

Rewrite Rule Inference Using Equality Saturation

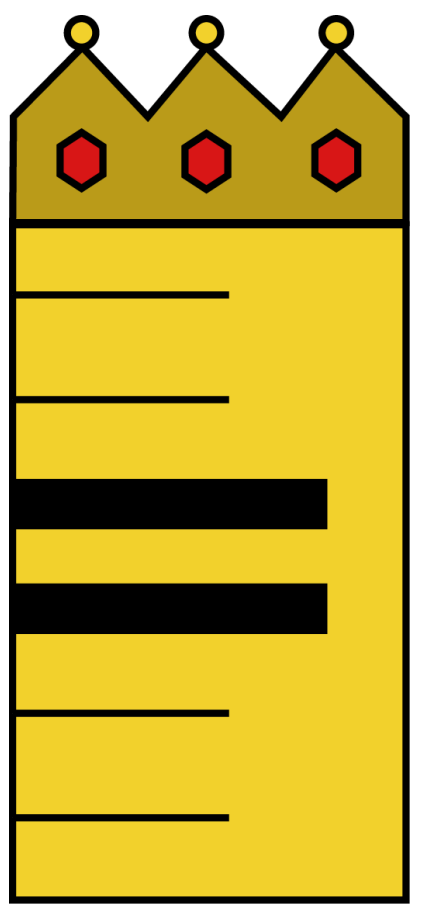

Chandrakana Nandi, Max Willsey, Amy Zhu, Yisu Remy Wang, Brett Saiki,
Adam Anderson, Adriana Schulz, Dan Grossman, Zachary Tatlock

OOPSLA 2021

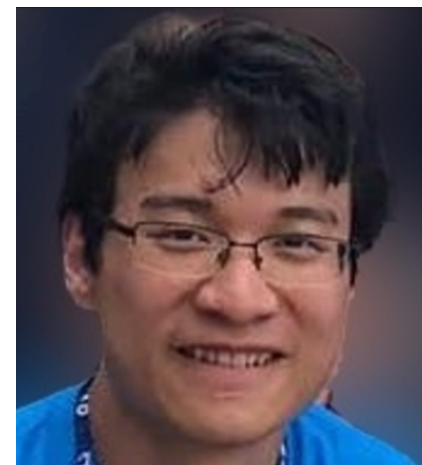

Rewrite Rules Are Ubiquitous!

CVC4



Z3



Halide



Compilers

Program Synthesizers

Simplifiers / Optimizers

SMT Solvers

ML Frameworks

Rewrite Engines must be Efficient and Reliable!

CVC4



Z3



Halide



Compilers

Program Synthesizers

Simplifiers / Optimizers

SMT Solvers

ML Frameworks

Performance and reliability are key for a TRS [Newcomb et al. OOPSLA'20]

But...Designing Rewrite Rules is still Hard!

Who *writes* the *rewrite* rules?

Typically hand written by experts

Time consuming, often takes years

Too few / too many rules

Unsound rules

A 3-Step Approach for Inferring Rewrite Rules

A 3-Step Approach for Inferring Rewrite Rules

Enumerate terms
from a grammar

$a, b, 0, +, \dots$

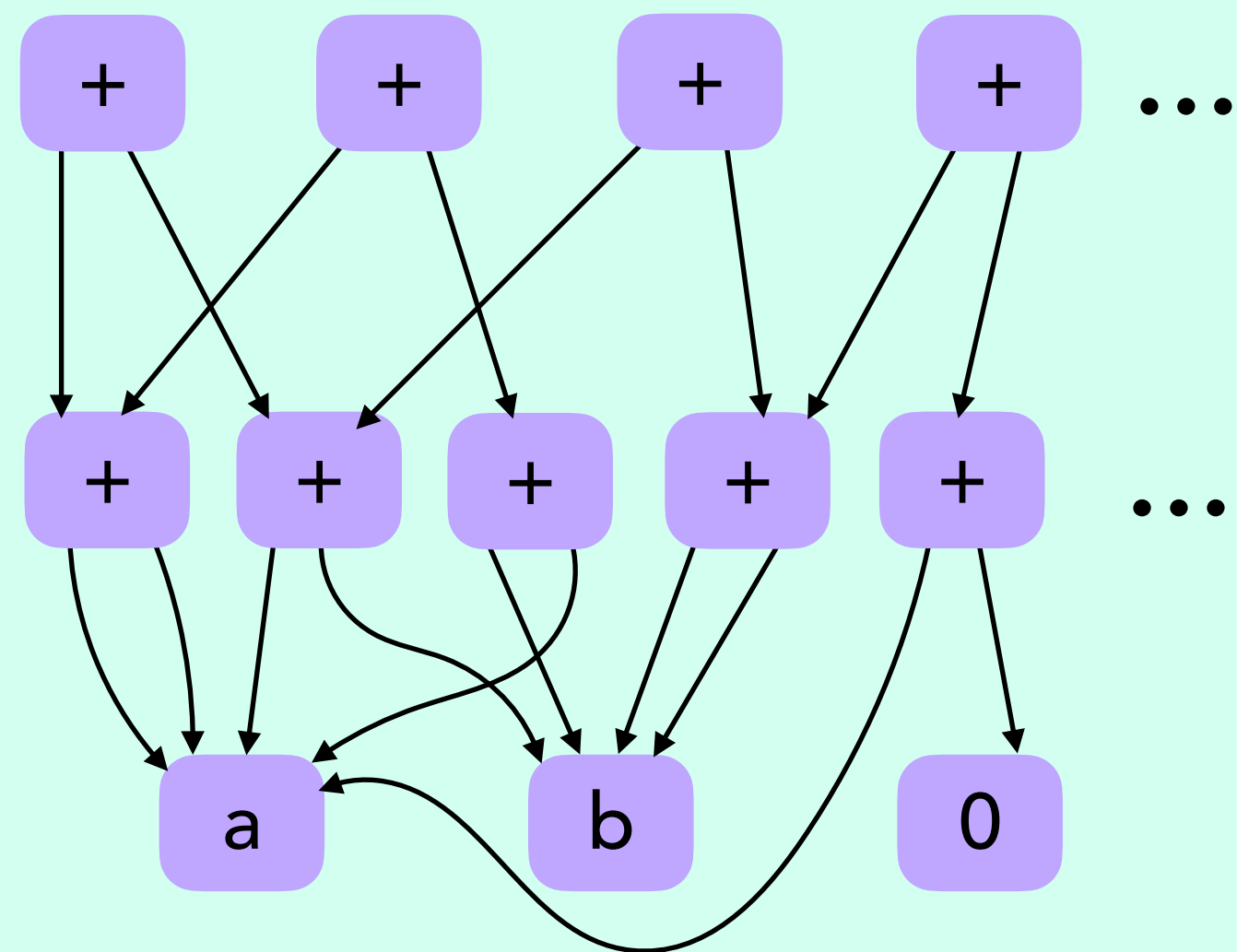

A 3-Step Approach for Inferring Rewrite Rules

Enumerate terms
from a grammar

$a, b, 0, +, \dots$

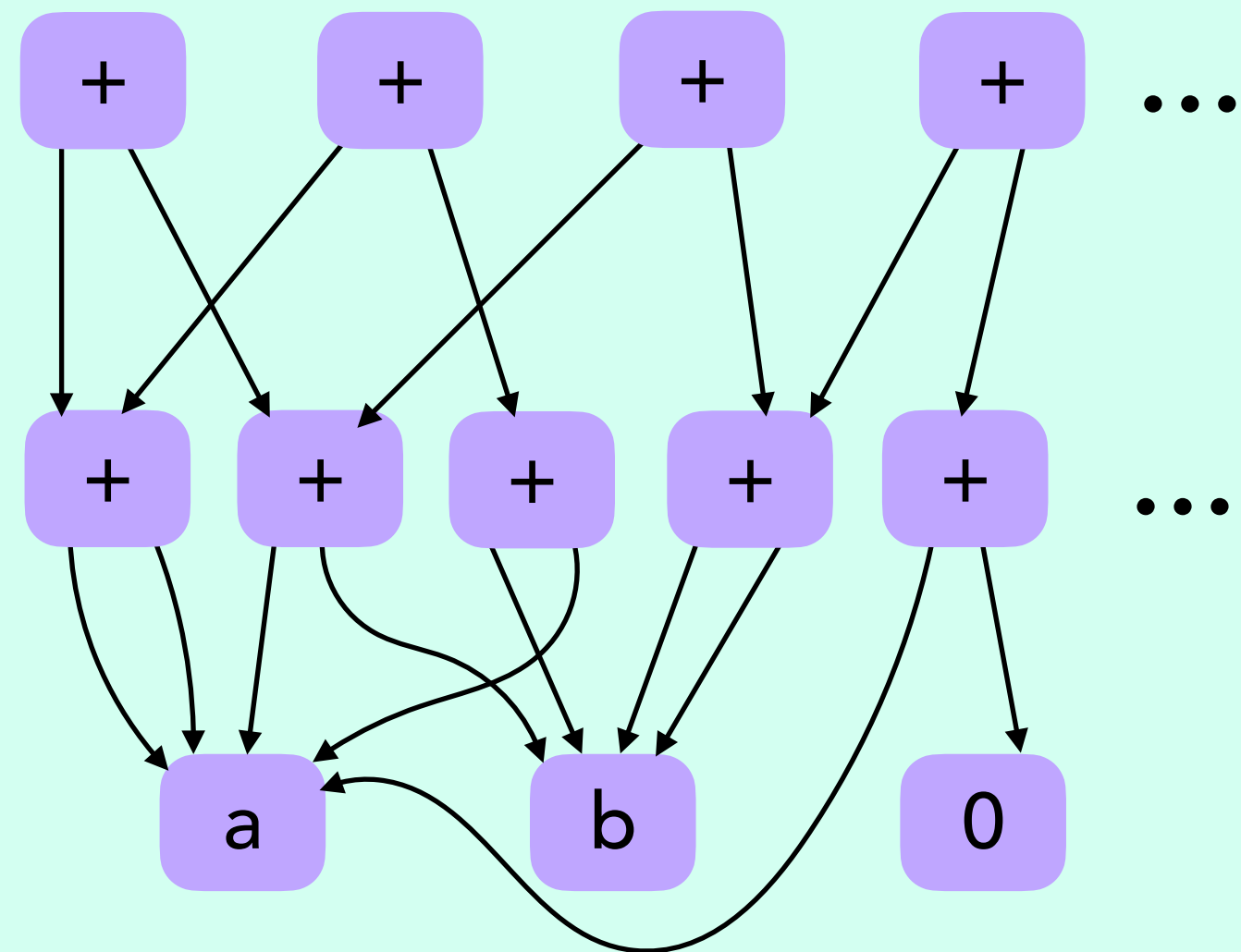

Find candidates: interpret
over concrete inputs

 "Fingerprints"

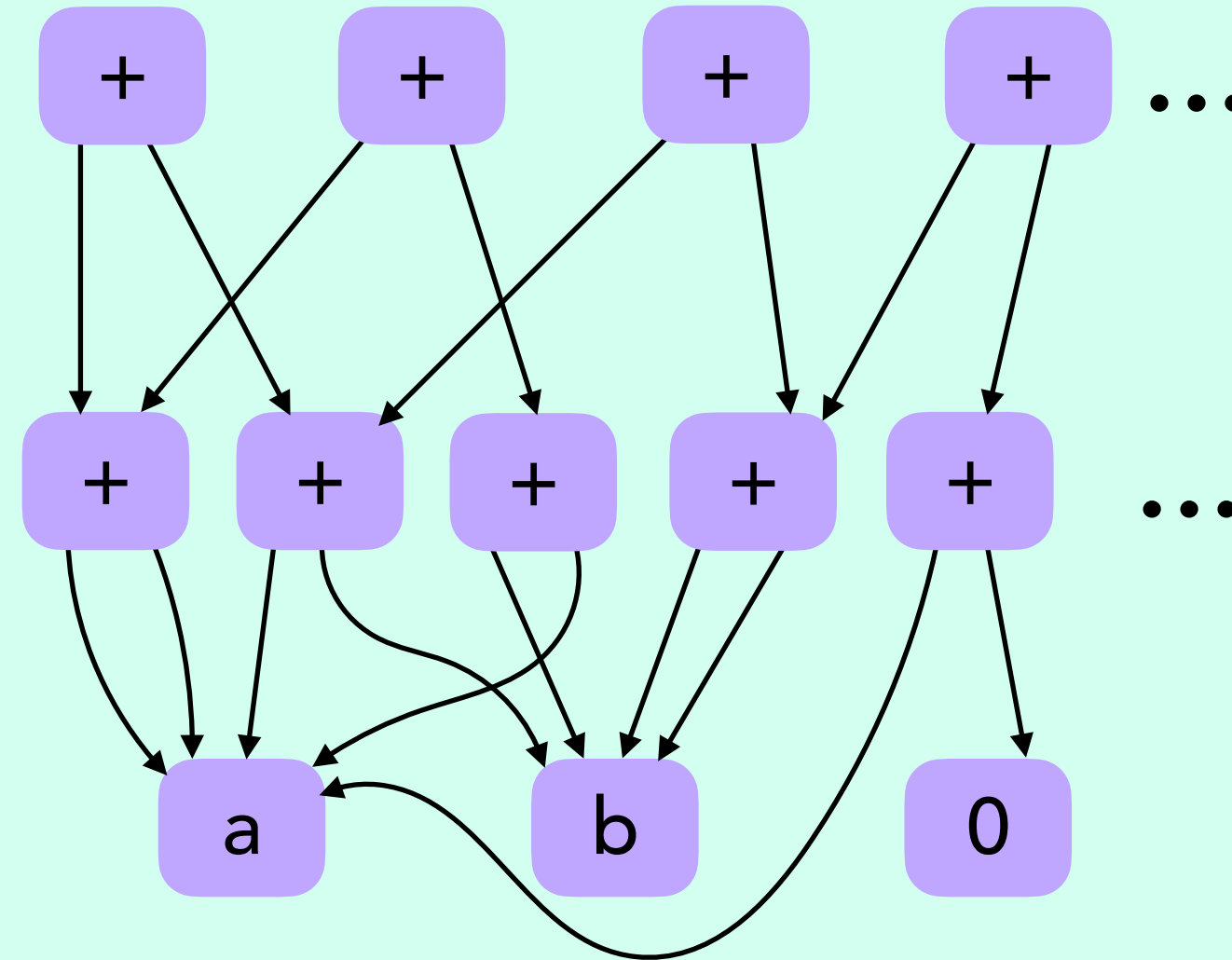

A 3-Step Approach for Inferring Rewrite Rules

Enumerate terms
from a grammar

$a, b, 0, +, \dots$

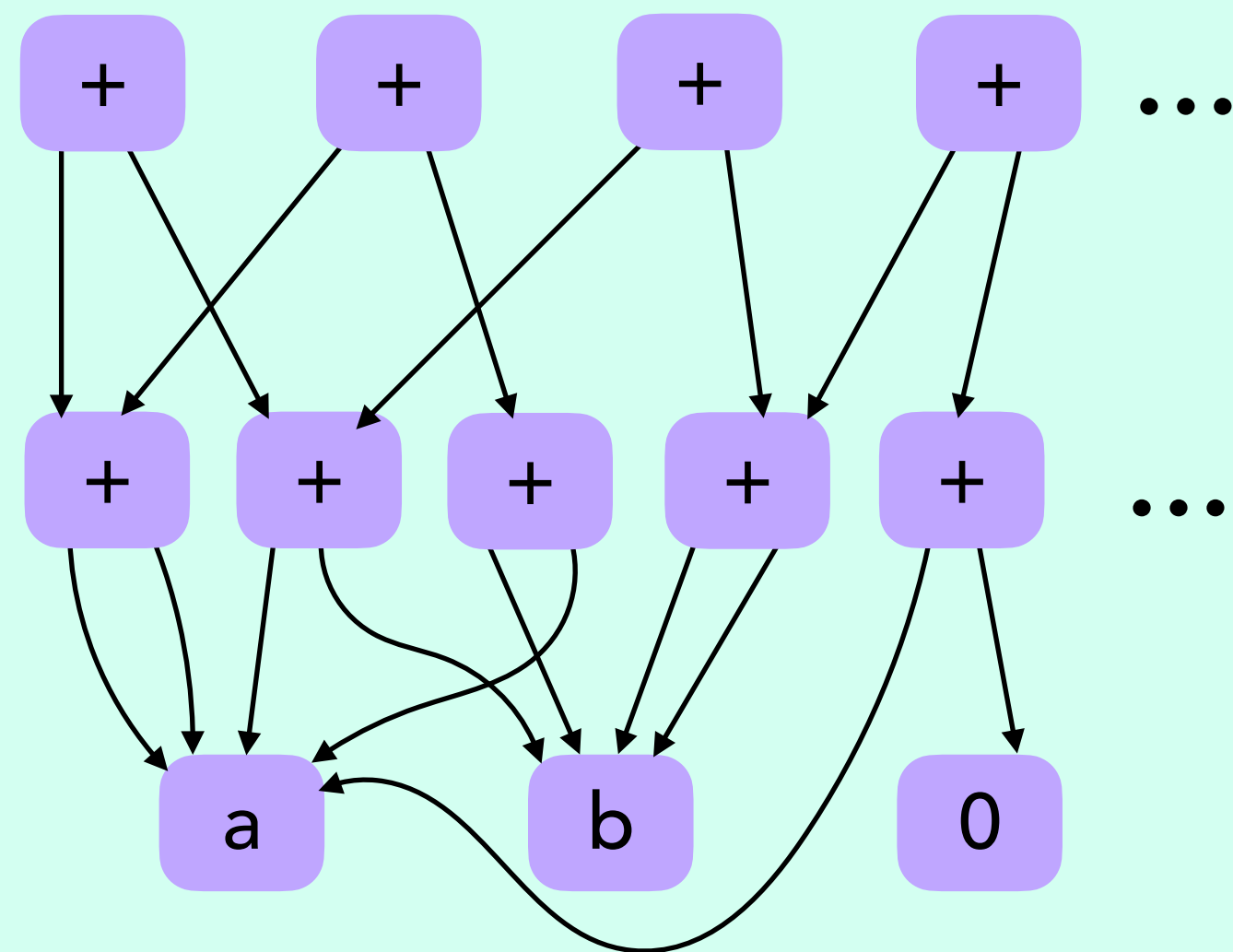

Find candidates: interpret
over concrete inputs

 "Fingerprints"

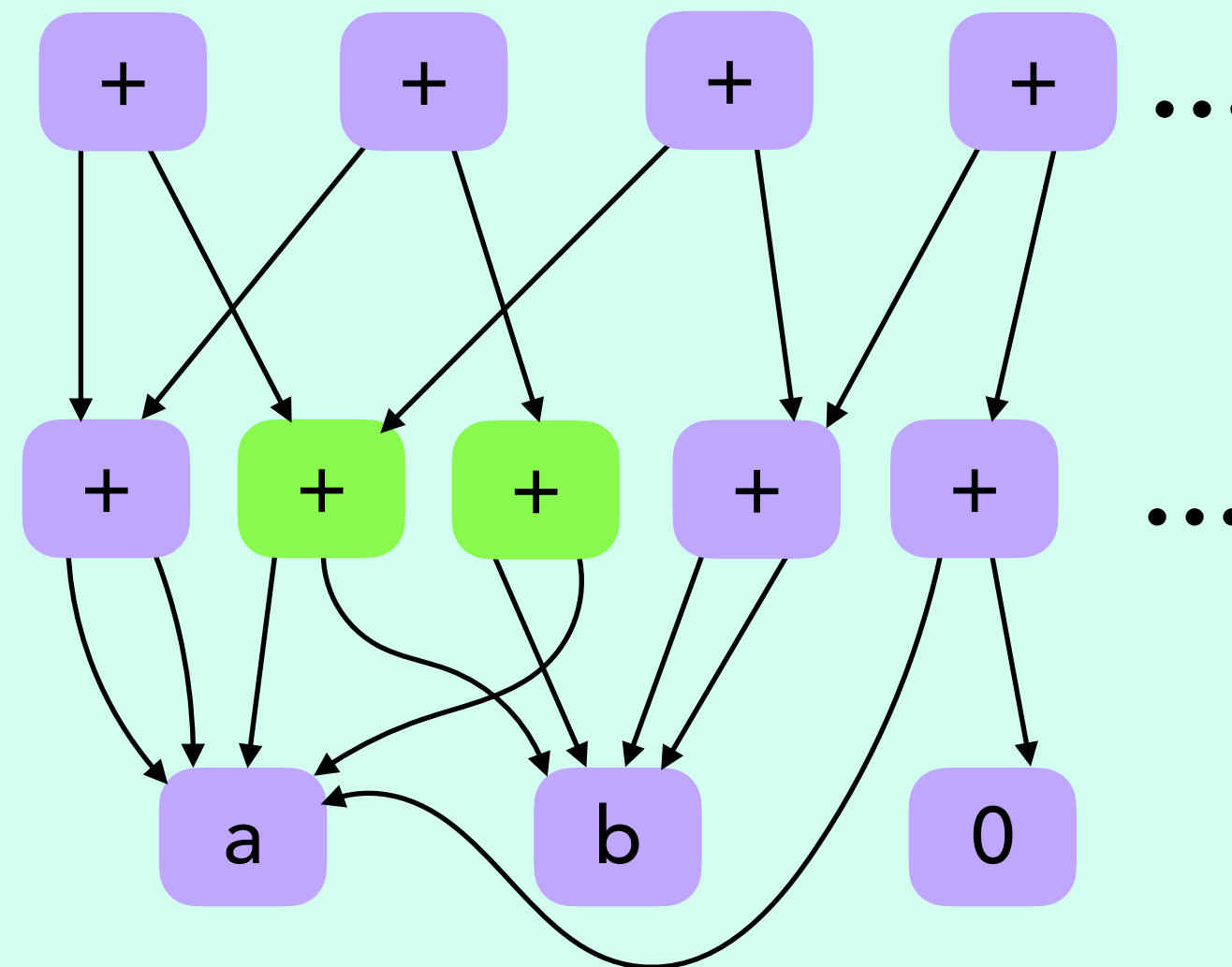

$$(x + y) \longleftrightarrow (y + x)$$

A 3-Step Approach for Inferring Rewrite Rules

Enumerate terms
from a grammar

$a, b, 0, +, \dots$

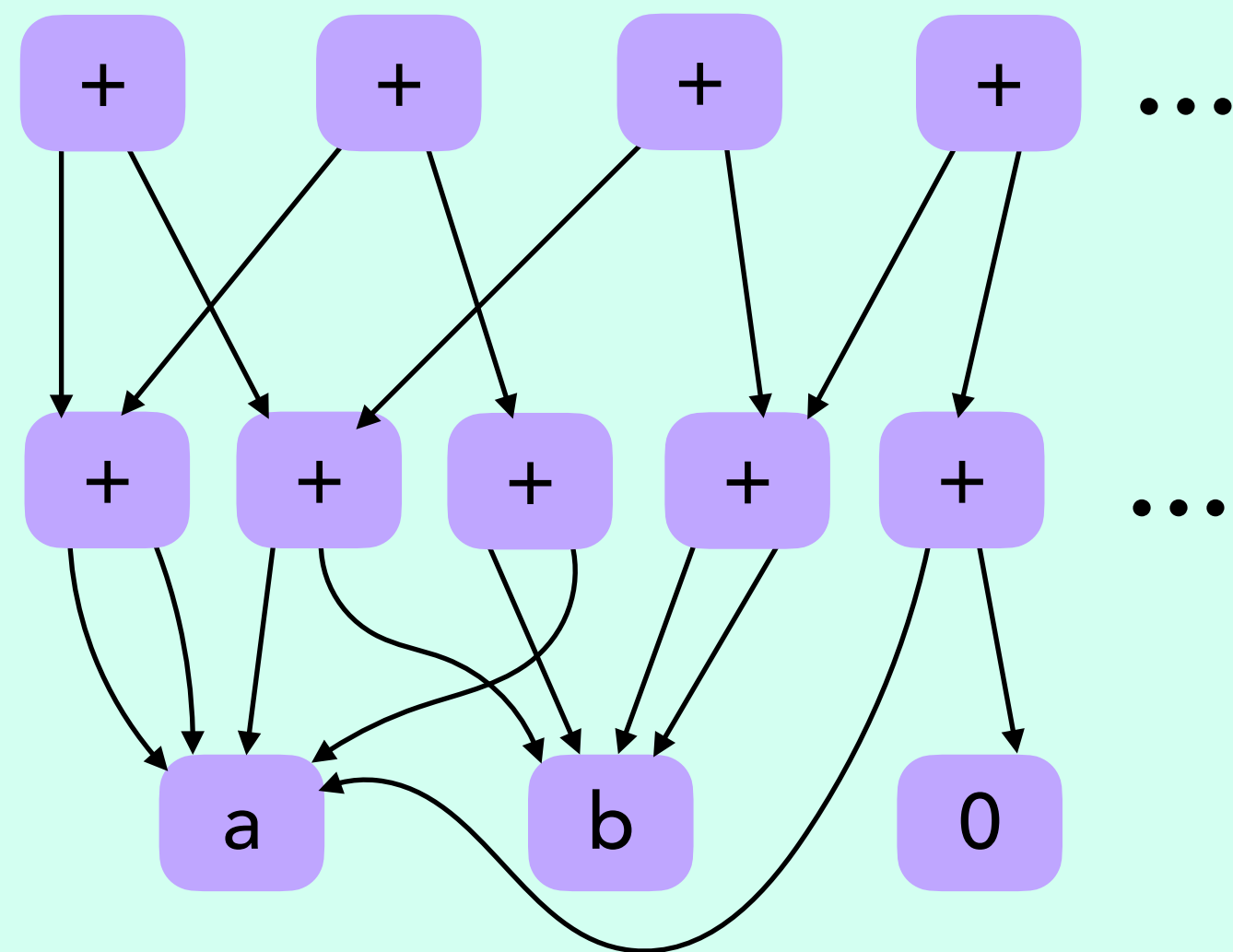

Find candidates: interpret
over concrete inputs

 "Fingerprints"

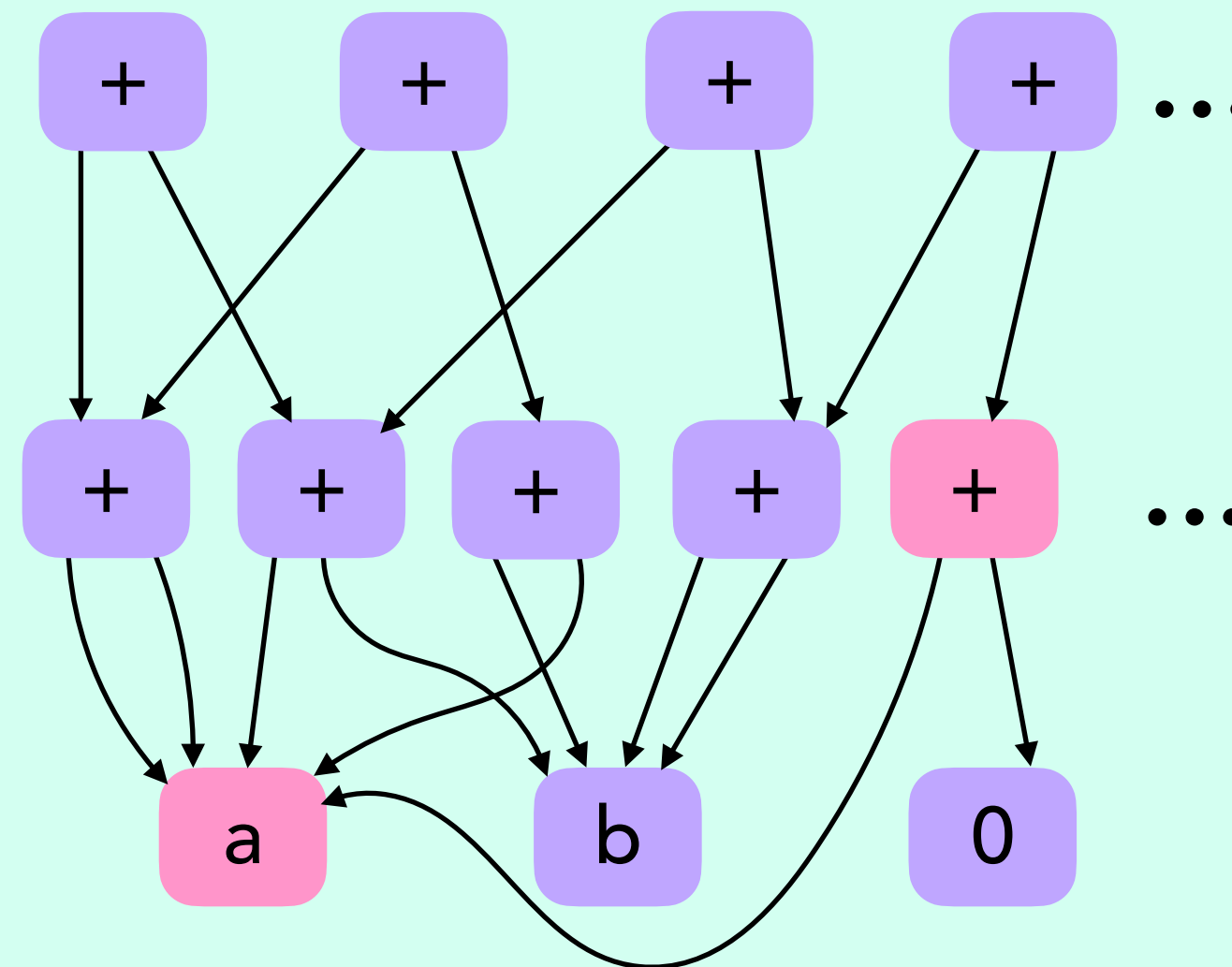

$(x + 0) \leftrightarrow x$

A 3-Step Approach for Inferring Rewrite Rules

Enumerate terms
from a grammar

$a, b, 0, +, \dots$

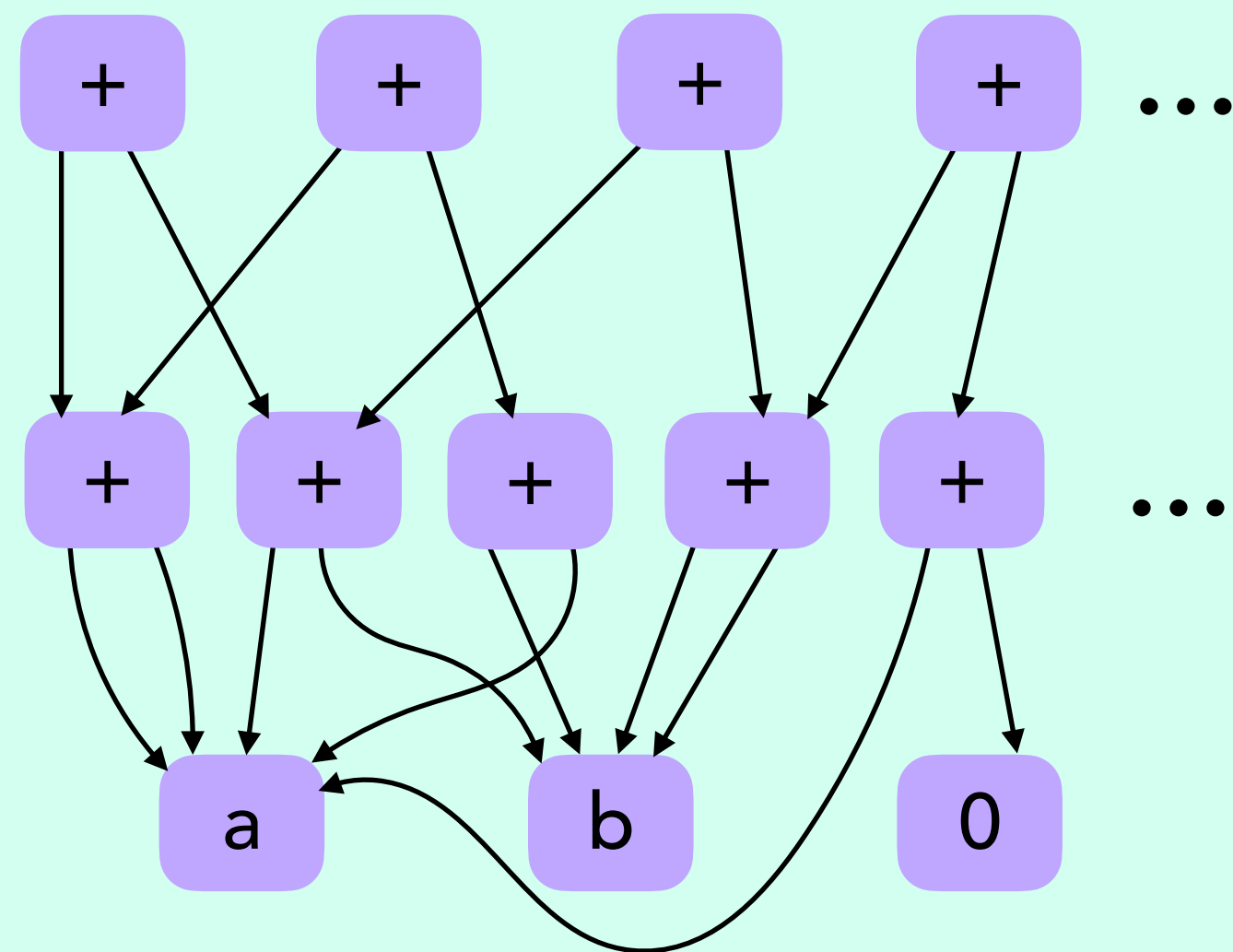

Find candidates: interpret
over concrete inputs



"Fingerprints"

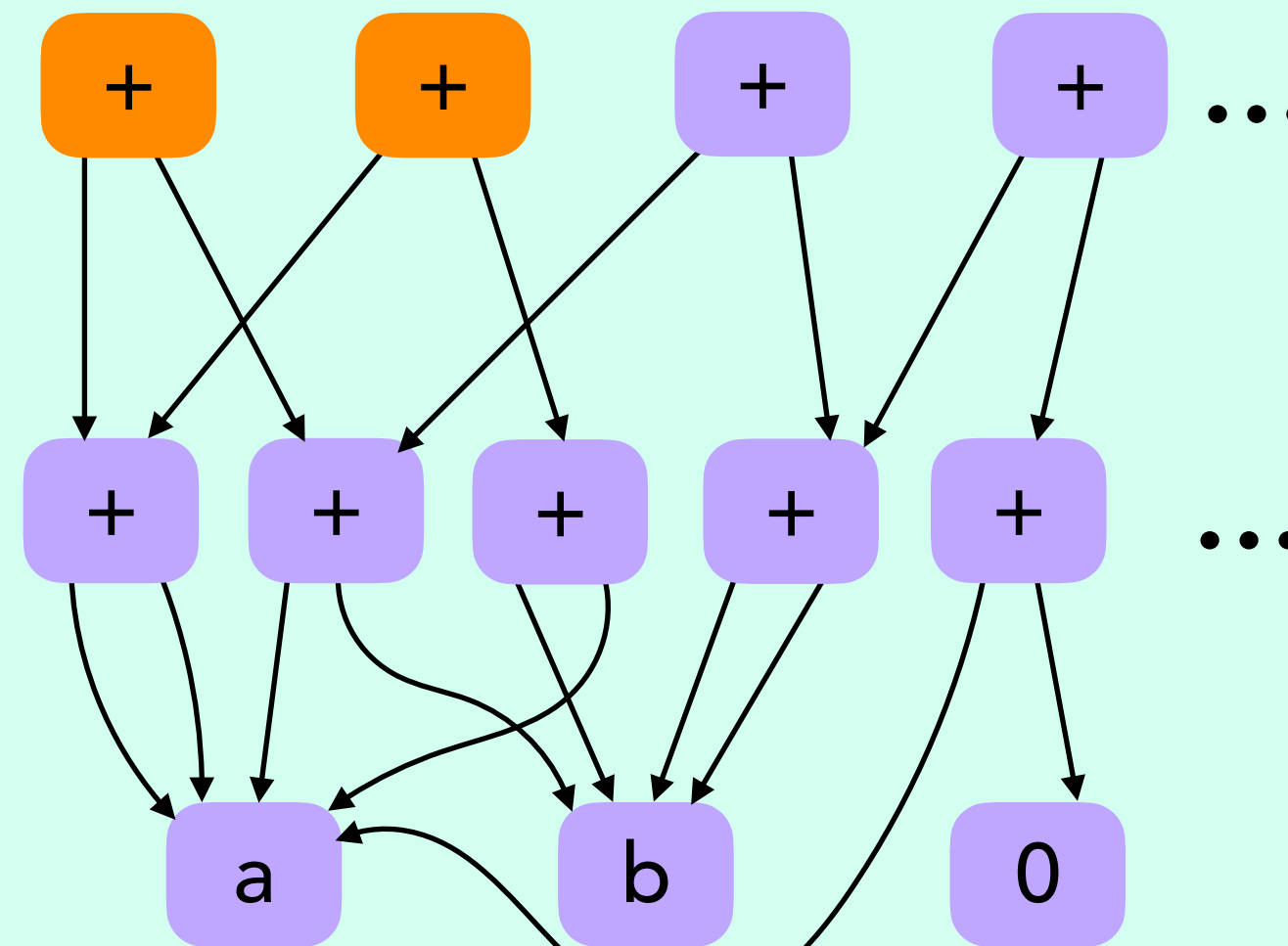

$$(x + x) + (x + y) \leftrightarrow (x + x) + (y + x)$$

A 3-Step Approach for Inferring Rewrite Rules

Enumerate terms
from a grammar

$a, b, 0, +, \dots$

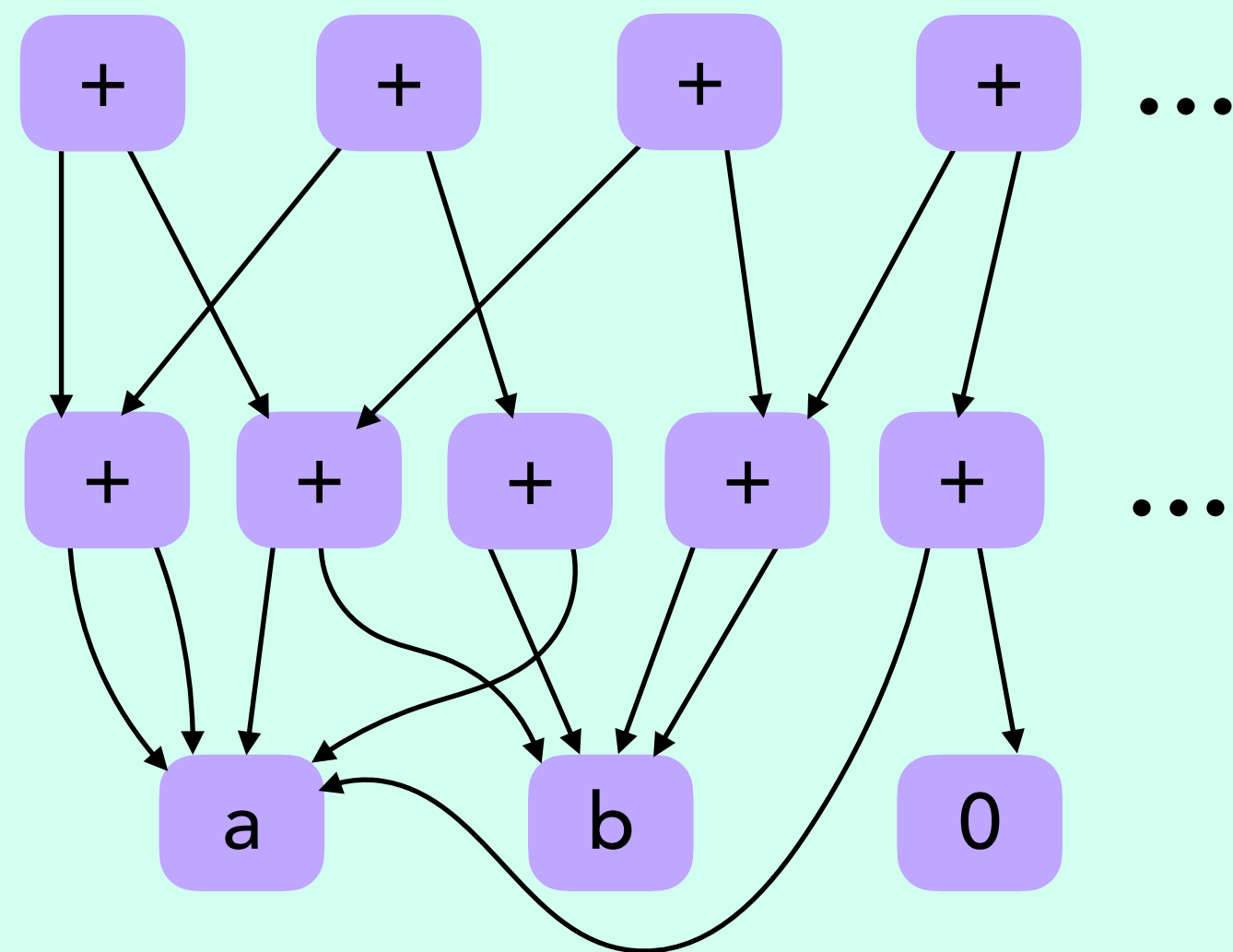

Find candidates: interpret
over concrete inputs

 "Fingerprints"

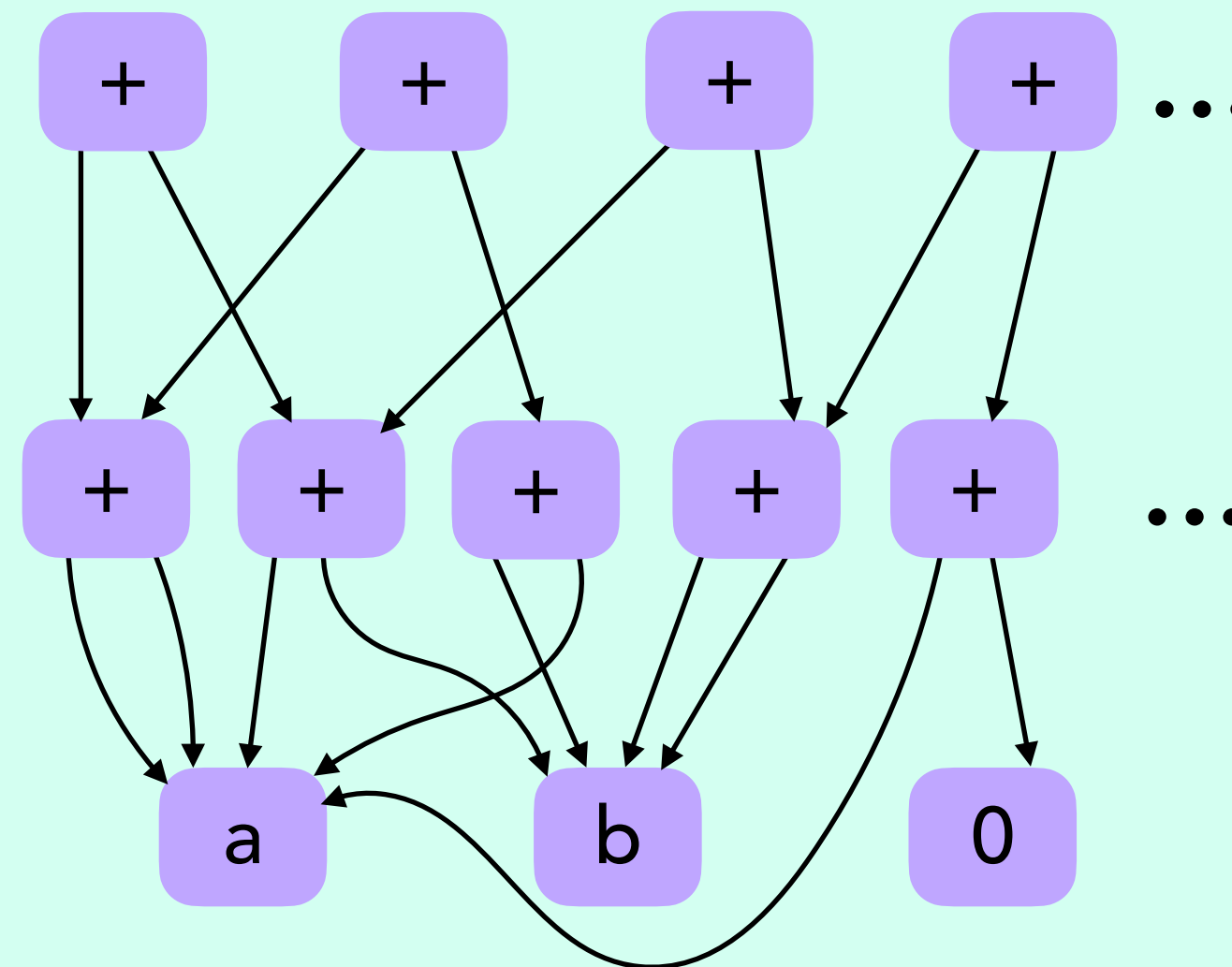

Filter candidates
to get final ruleset

Remove redundant rules

$$\begin{array}{l} x + 0 \quad \longleftrightarrow \quad 0 + x \\ y + 0 \quad \longleftrightarrow \quad 0 + y \\ x + y \quad \longleftrightarrow \quad y + x \end{array}$$

A 3-Step Approach for Inferring Rewrite Rules

Enumerate terms
from a grammar

**Exponentially
many terms!**

Find candidates: interpret
over concrete inputs

**Too many
candidates, some
potentially
unsound!**

Filter candidates
to get final ruleset

**Hard to find a
small, useful
ruleset**

Equality Saturation for Inferring Rewrite Rules

This Talk:

Inferring *Small, Useful* Rulesets *Faster*
using **Equality Saturation!**

What is *Equality Saturation*?

What is *Equality Saturation*?

$$(a * 2) / 2$$

What is *Equality Saturation*?

$$(a * 2) / 2 \quad a$$

What is *Equality Saturation*?

$$(a * 2) / 2 \quad \xrightarrow{\quad ??? \quad} \quad a$$

What is *Equality Saturation*?

$$(a * 2) / 2 \quad \longrightarrow \quad a$$

Rewrite
rules!

$$(x * y) / z \longleftrightarrow x * (y / z)$$

$$y / y \longrightarrow 1$$

$$x * 1 \longleftrightarrow x$$

How to Apply Rewrite Rules?

$$(a * 2) / 2 \xrightarrow{\text{yellow arrow}} a * (2 / 2)$$

$(x * y) / z \leftrightarrow x * (y / z)$

How to Apply Rewrite Rules?

$$(a * 2) / 2 \xrightarrow{\text{yellow arrow}} a * (2 / 2)$$

$(x * y) / z \leftrightarrow x * (y / z)$

$$a * (2 / 2) \xrightarrow{\text{yellow arrow}} a * 1$$

$y / y \rightarrow 1$

How to Apply Rewrite Rules?

$$(a * 2) / 2 \xrightarrow{\quad} a * (2 / 2)$$

$(x * y) / z \leftrightarrow x * (y / z)$

$$a * (2 / 2) \xrightarrow{\quad} a * 1$$

$y / y \rightarrow 1$

$$a * 1 \xrightarrow{\quad} a$$

$x * 1 \leftrightarrow x$

Destructively, In a Specific Order

Order of rule application affects result

Missed opportunities for optimizations

Same order may not work for all inputs

Old expression is lost

e.g., supporting commutativity is hard without additional tricks to ensure termination!

$x * 1 \leftrightarrow x$

Equality Saturation Mitigates Phase Ordering!

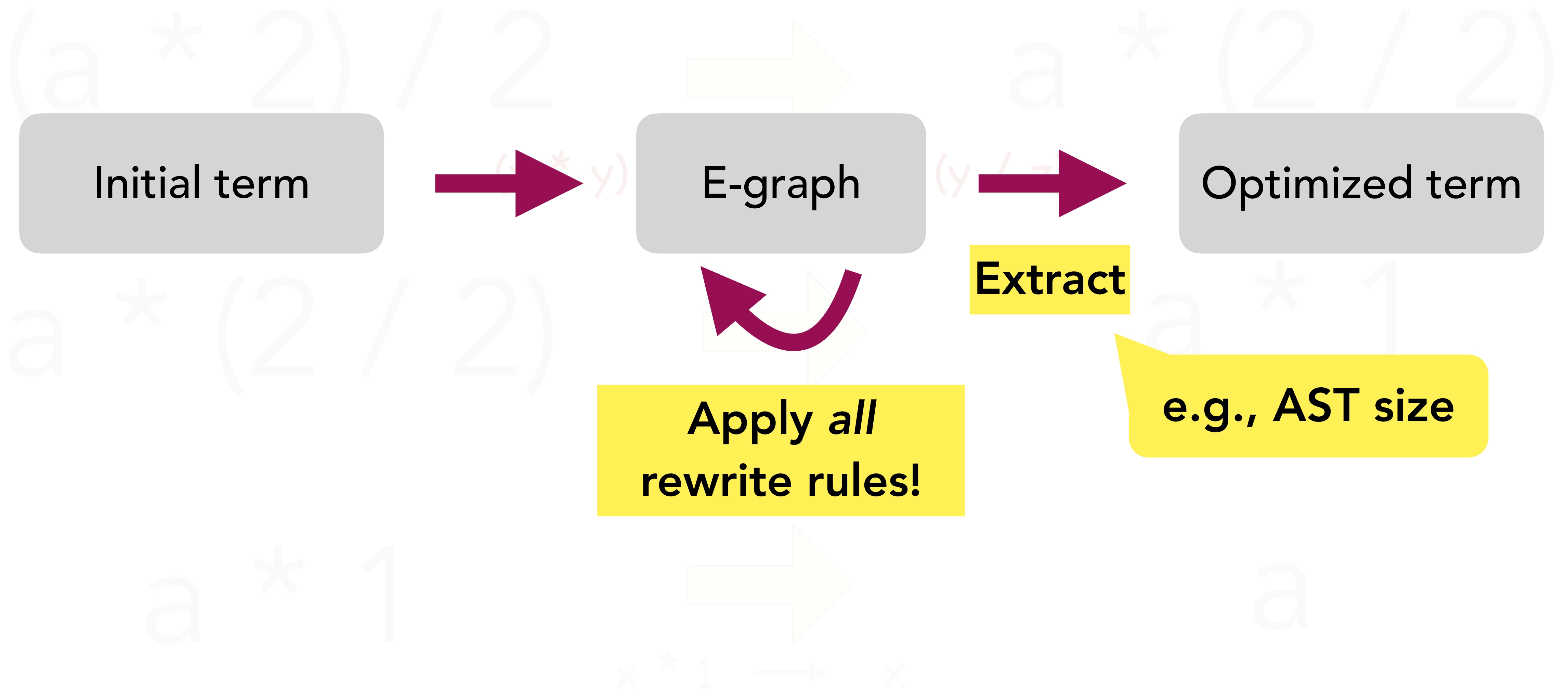

How Does Equality Saturation Work?

$$(a * 2) / 2$$

How Does Equality Saturation Work?

$(a * 2) / 2$

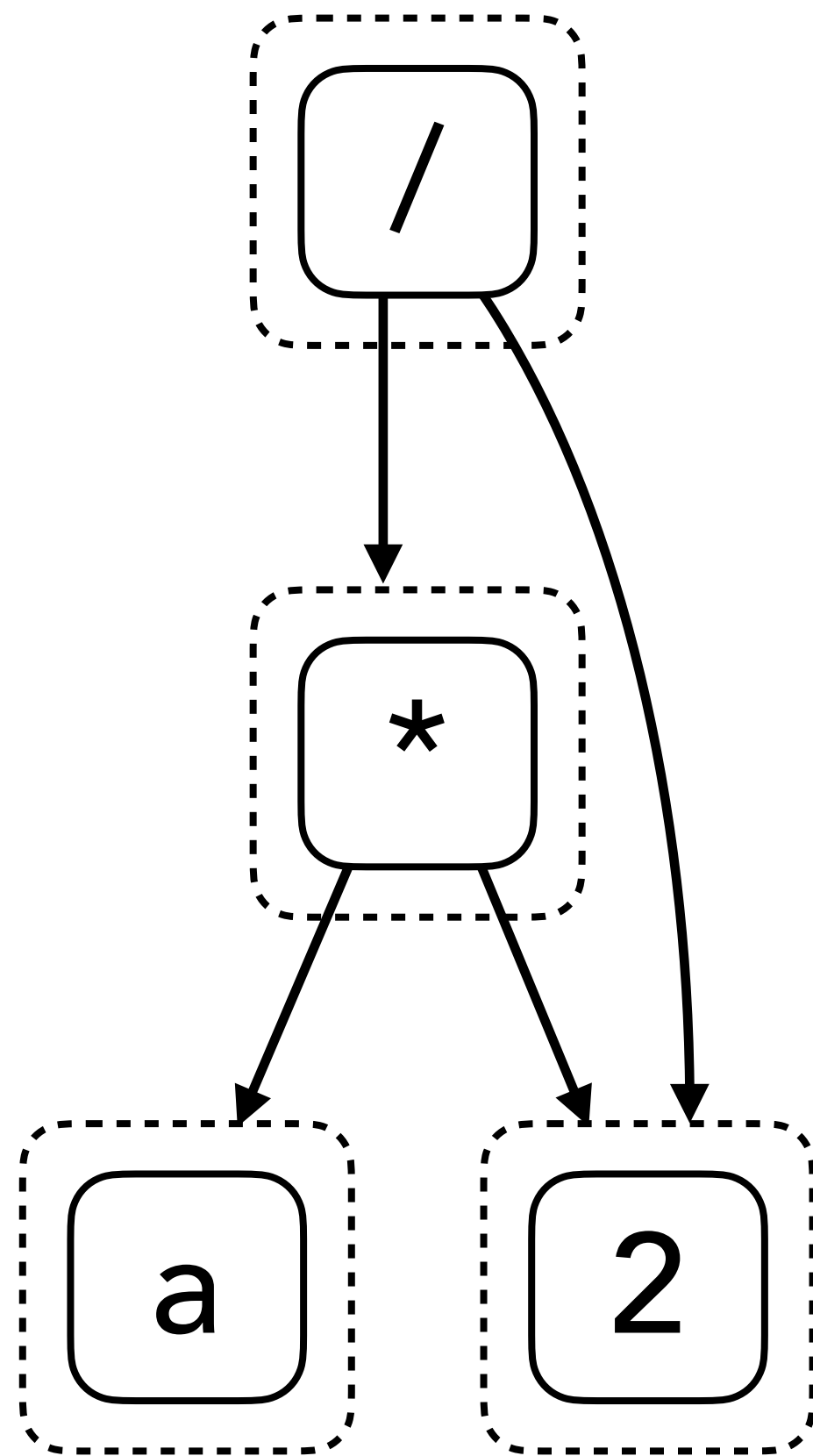

How Does Equality Saturation Work?

$$(a * 2) / 2$$

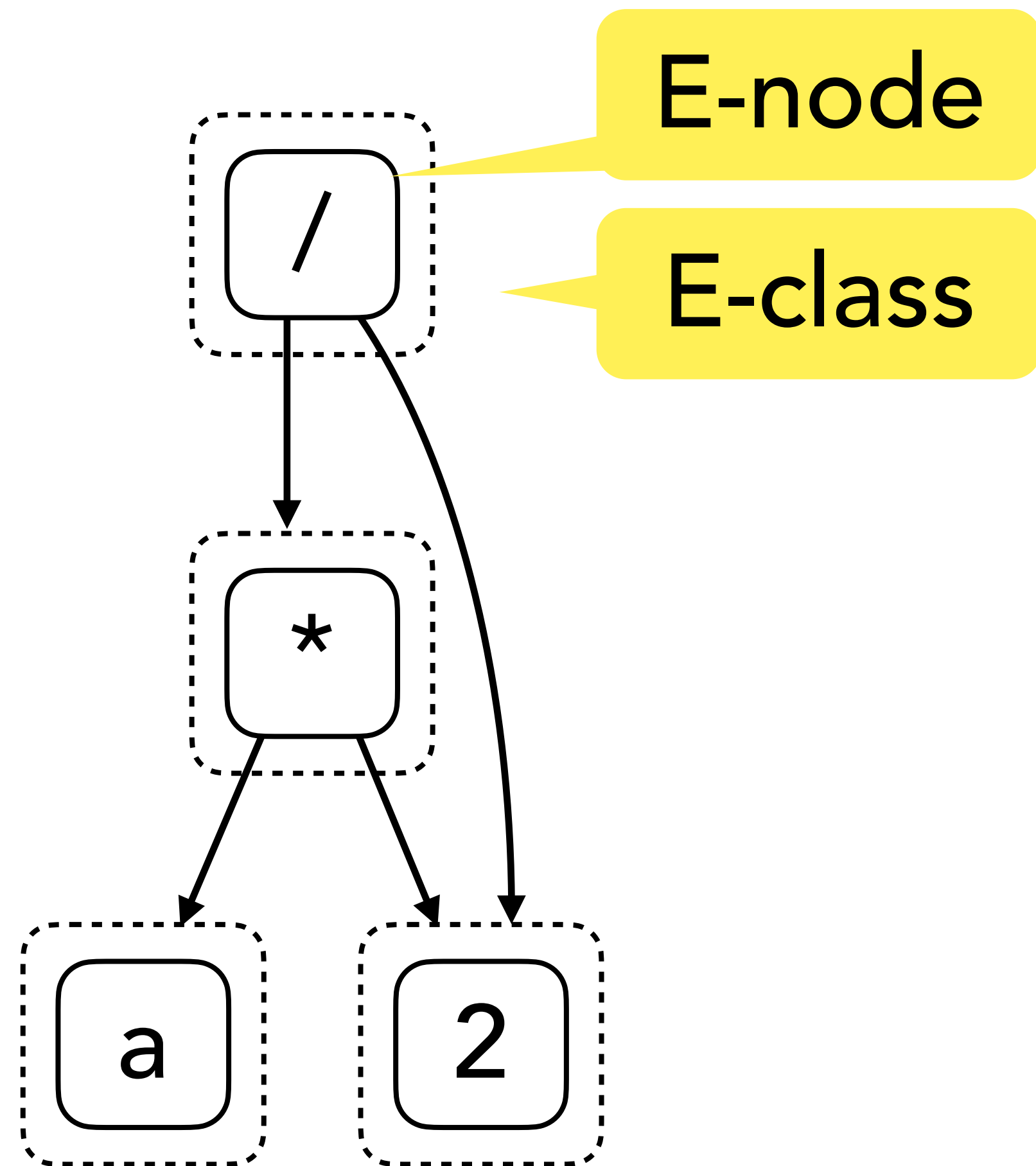

How Does Equality Saturation Work?

$(a * 2) / 2$

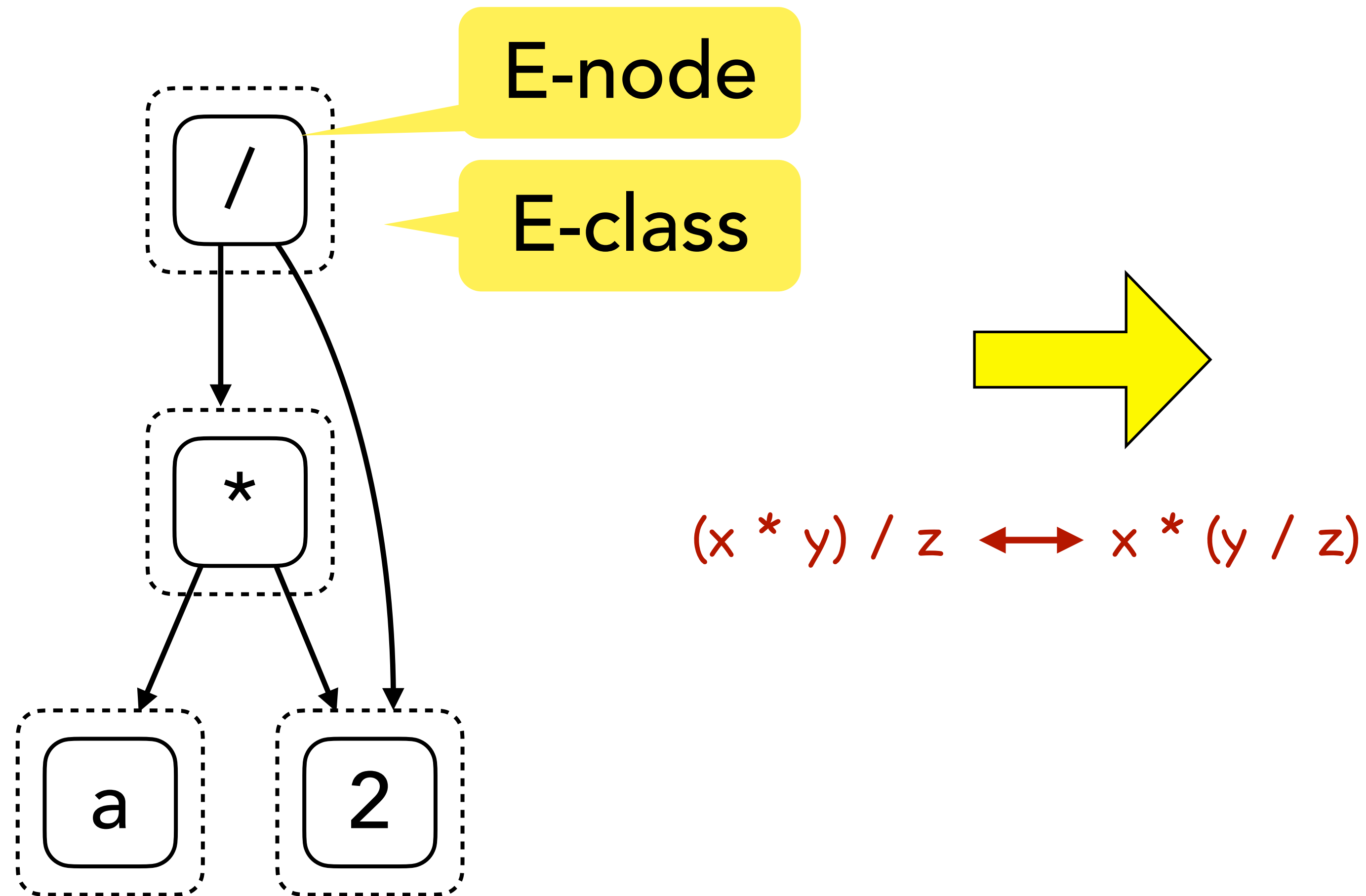

How Does Equality Saturation Work?

$(a * 2) / 2$

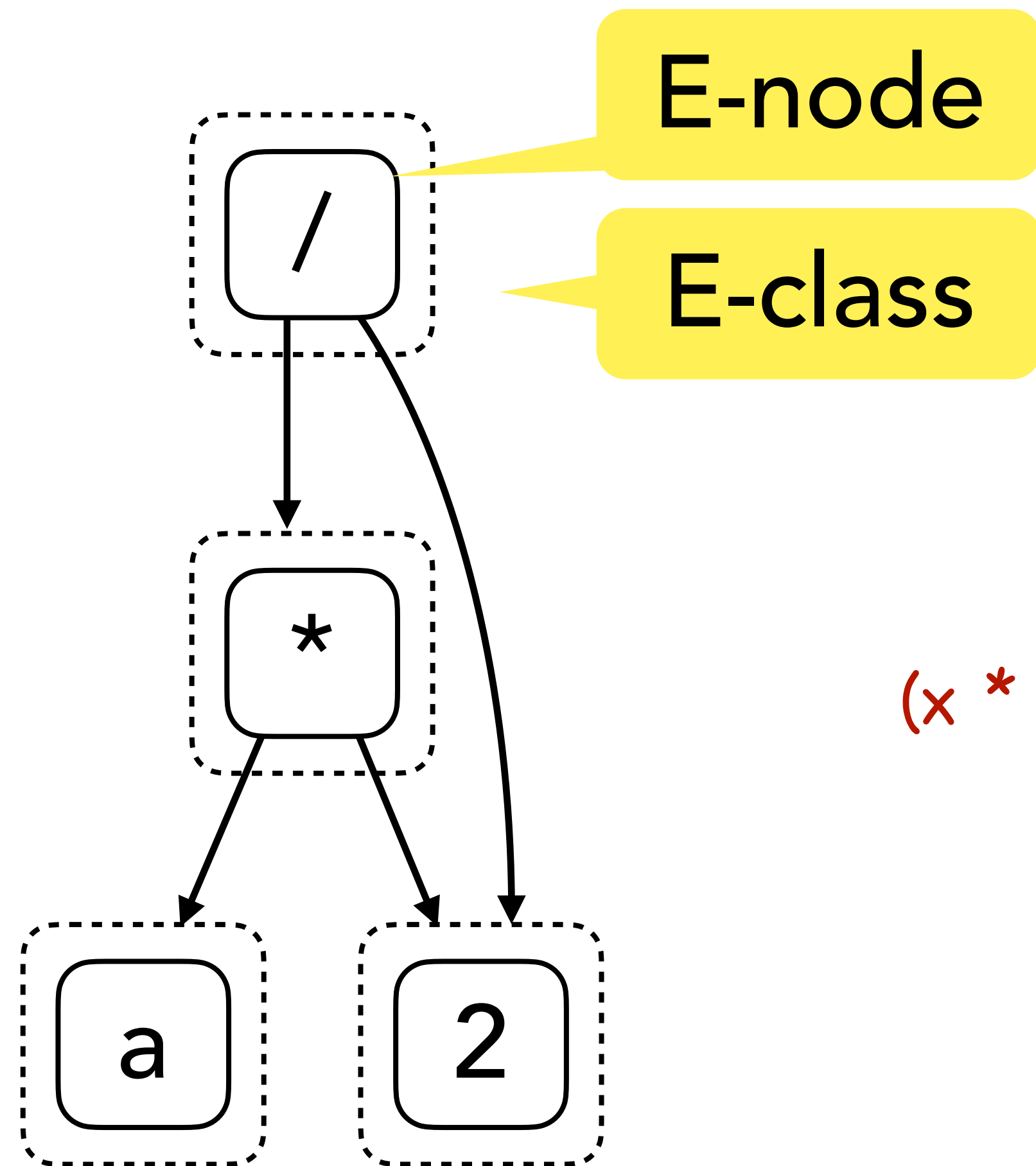

$(a * 2) / 2, a * (2 / 2)$

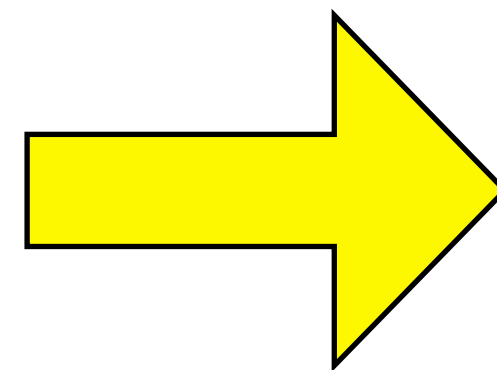

$$(x * y) / z \leftrightarrow x * (y / z)$$

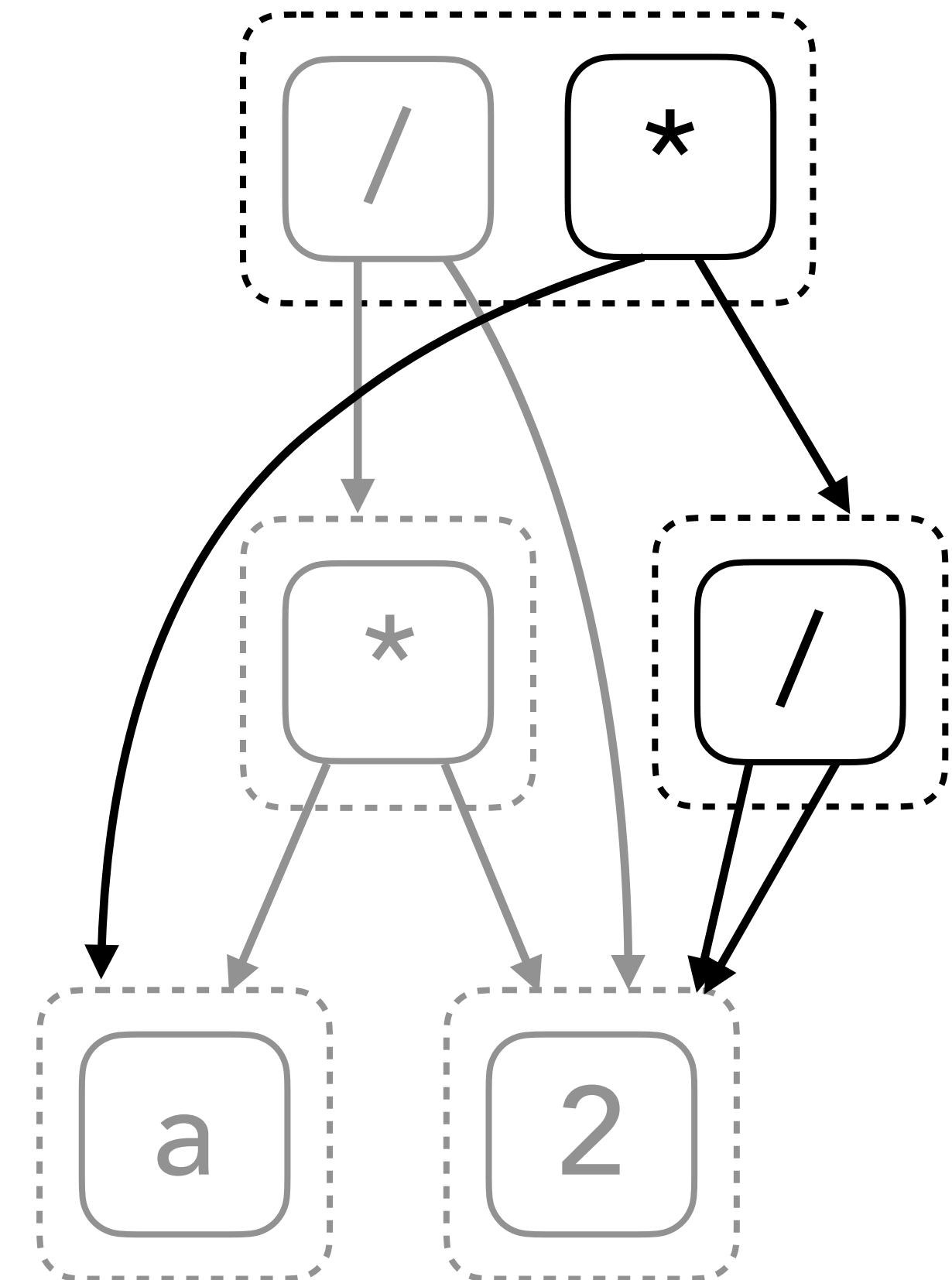

How Does Equality Saturation Work?

$(a * 2) / 2$

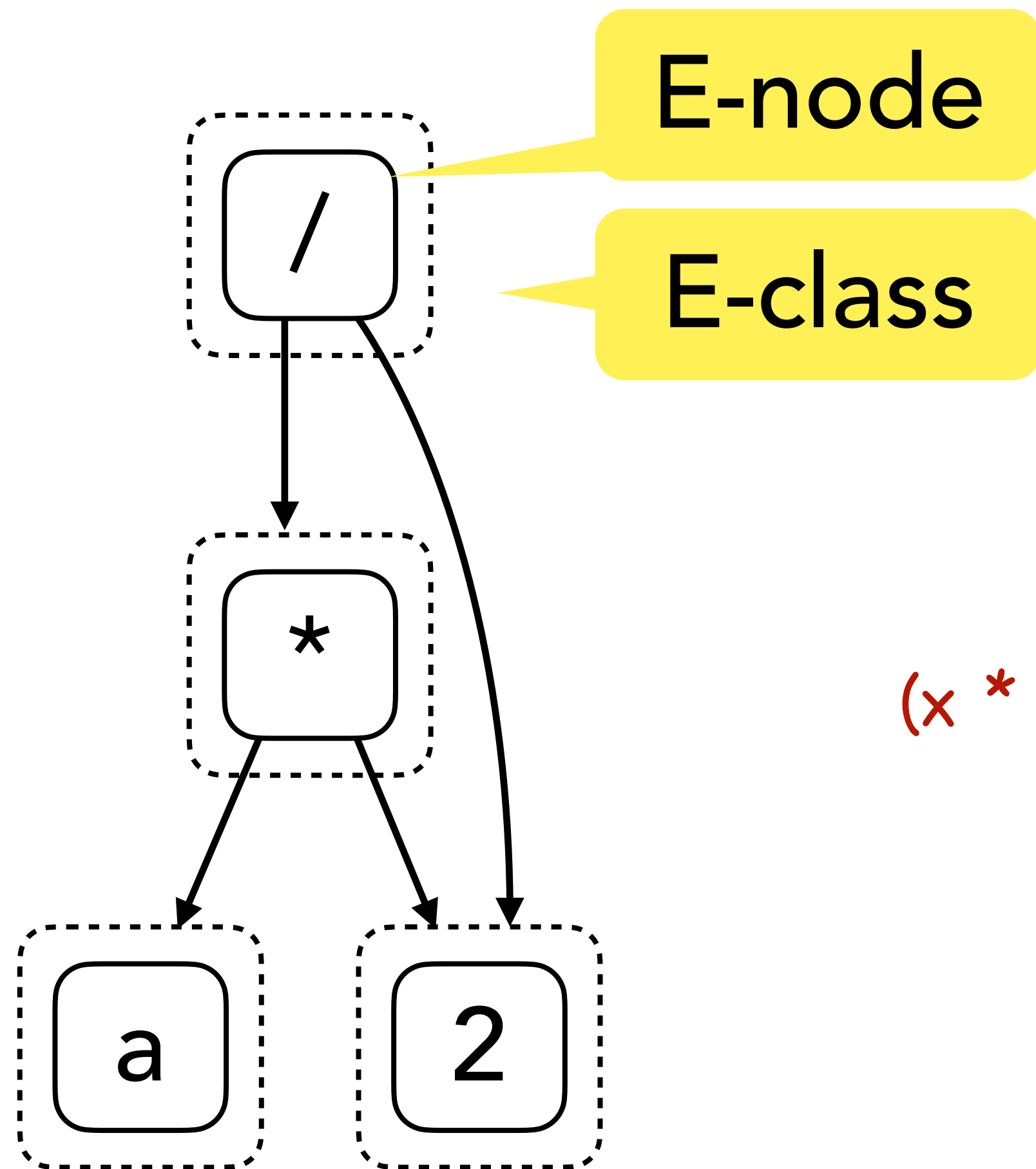

Represents
both terms!

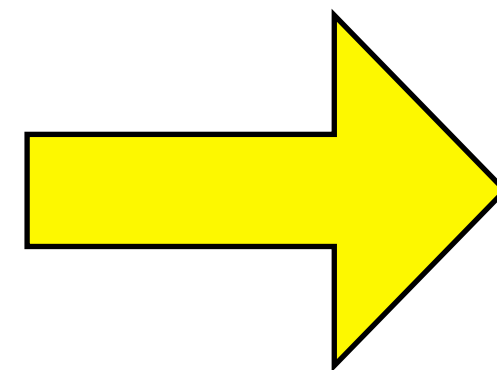

$(x * y) / z \leftrightarrow x * (y / z)$

$(a * 2) / 2, a * (2 / 2)$

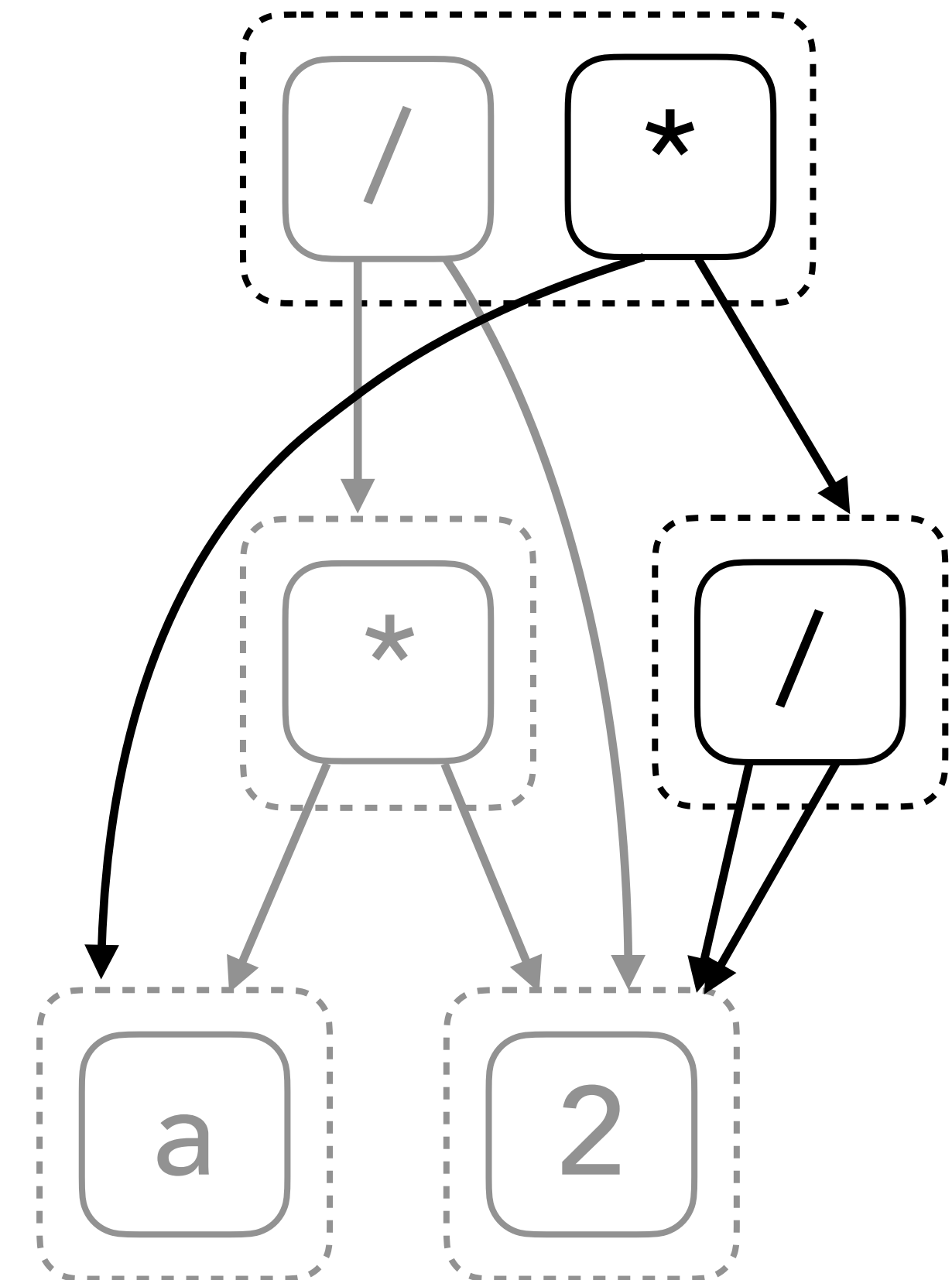

***Equality Saturation* for Inferring Rewrite Rules**

**Equality Saturation for not just
applying rewrites, but to also
infer them!**

Ruler

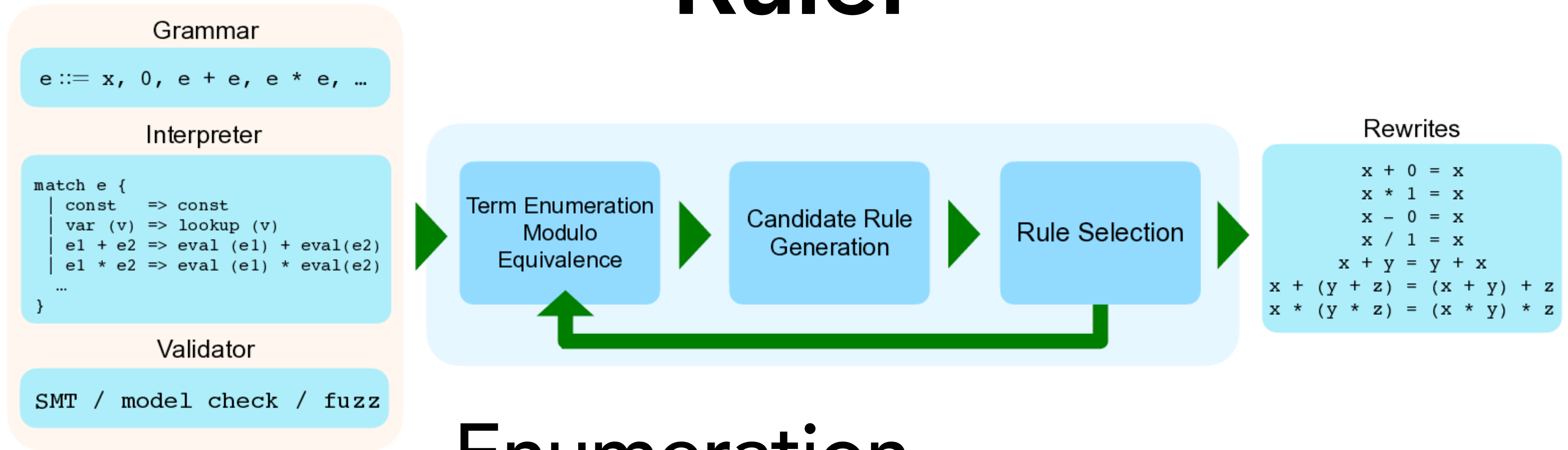

Enumeration

Candidate Generation

Rule Selection

Ruler

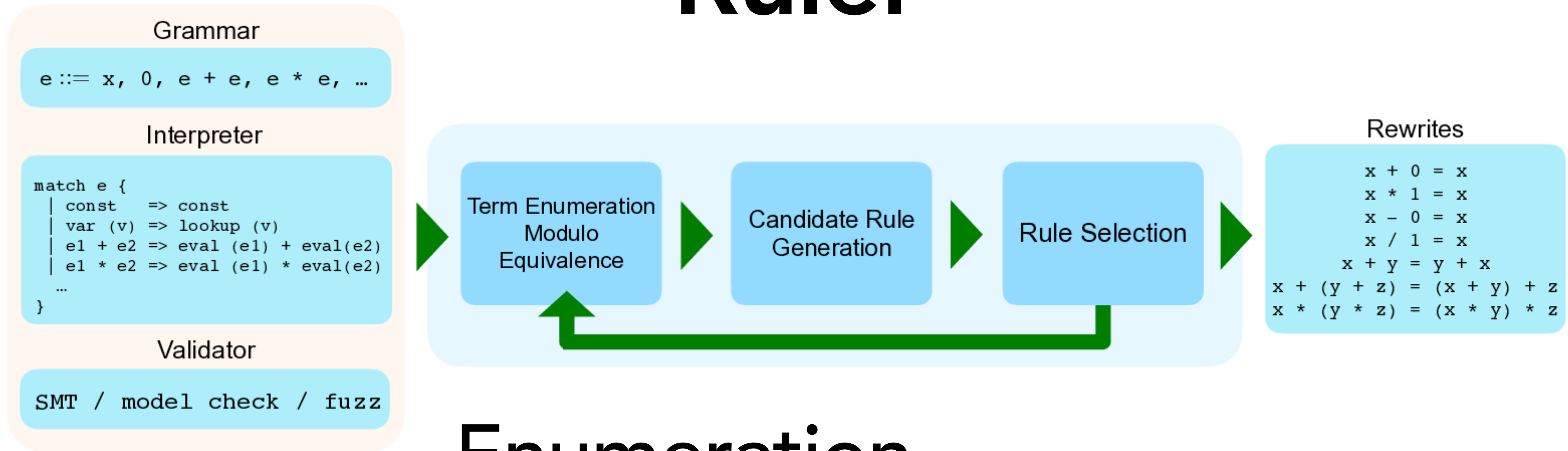

Enumeration

Candidate Generation

Rule Selection

Enumeration Modulo Equality Saturation

$a, b, 0, +, \dots$

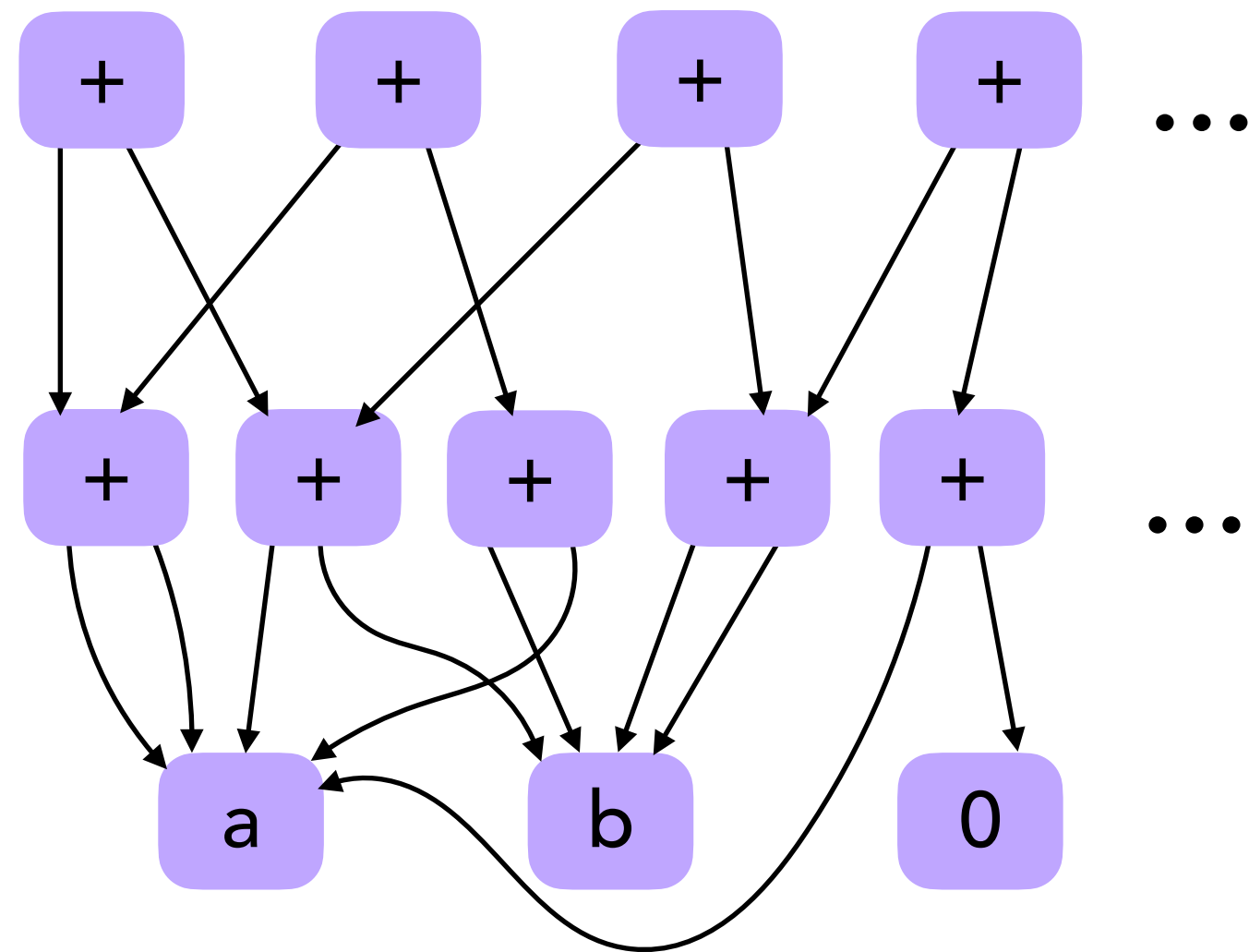

Exponentially
many terms!

Enumeration Modulo Equality Saturation

$a, b, 0, +, \dots$

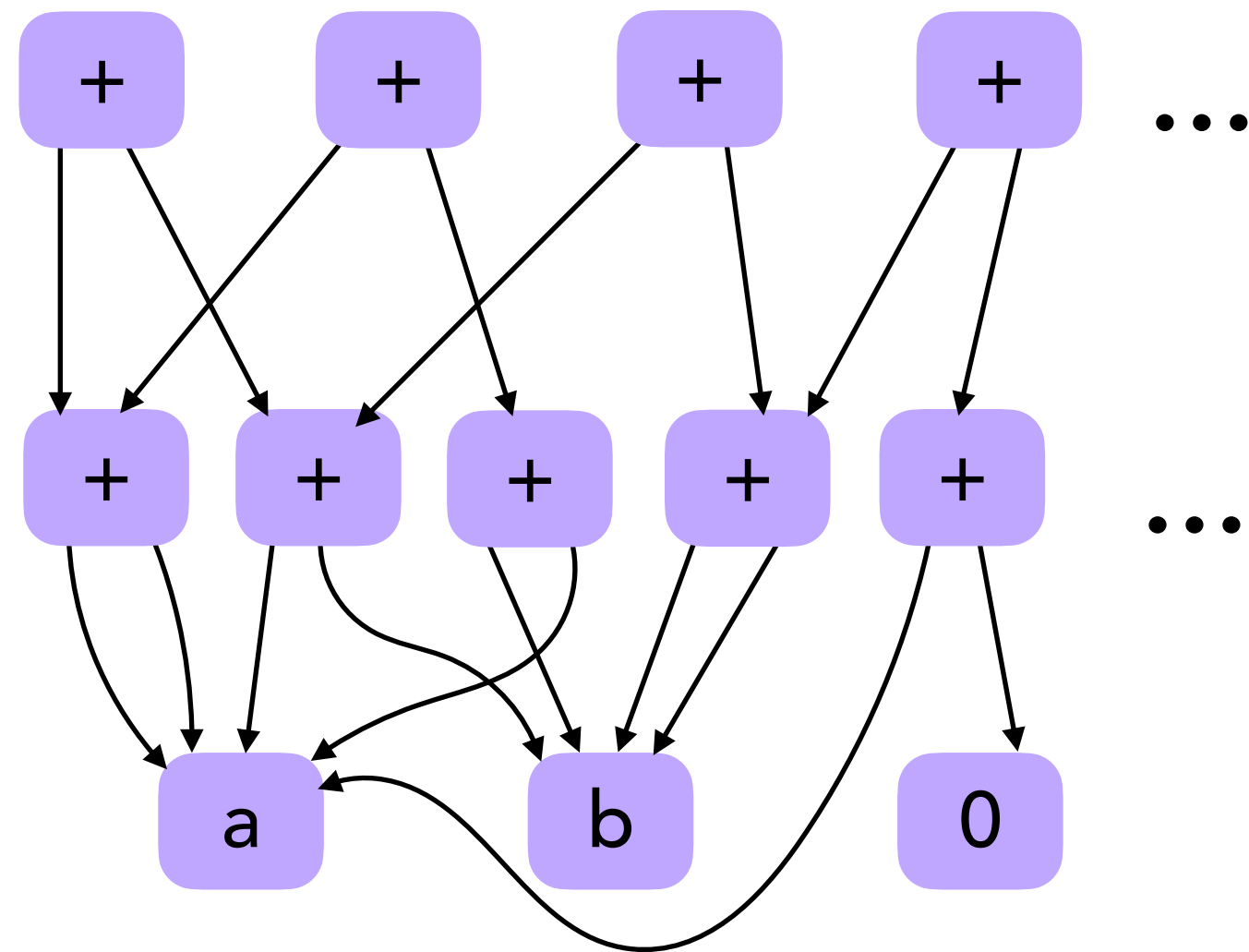

Exponentially
many terms!

E-classes

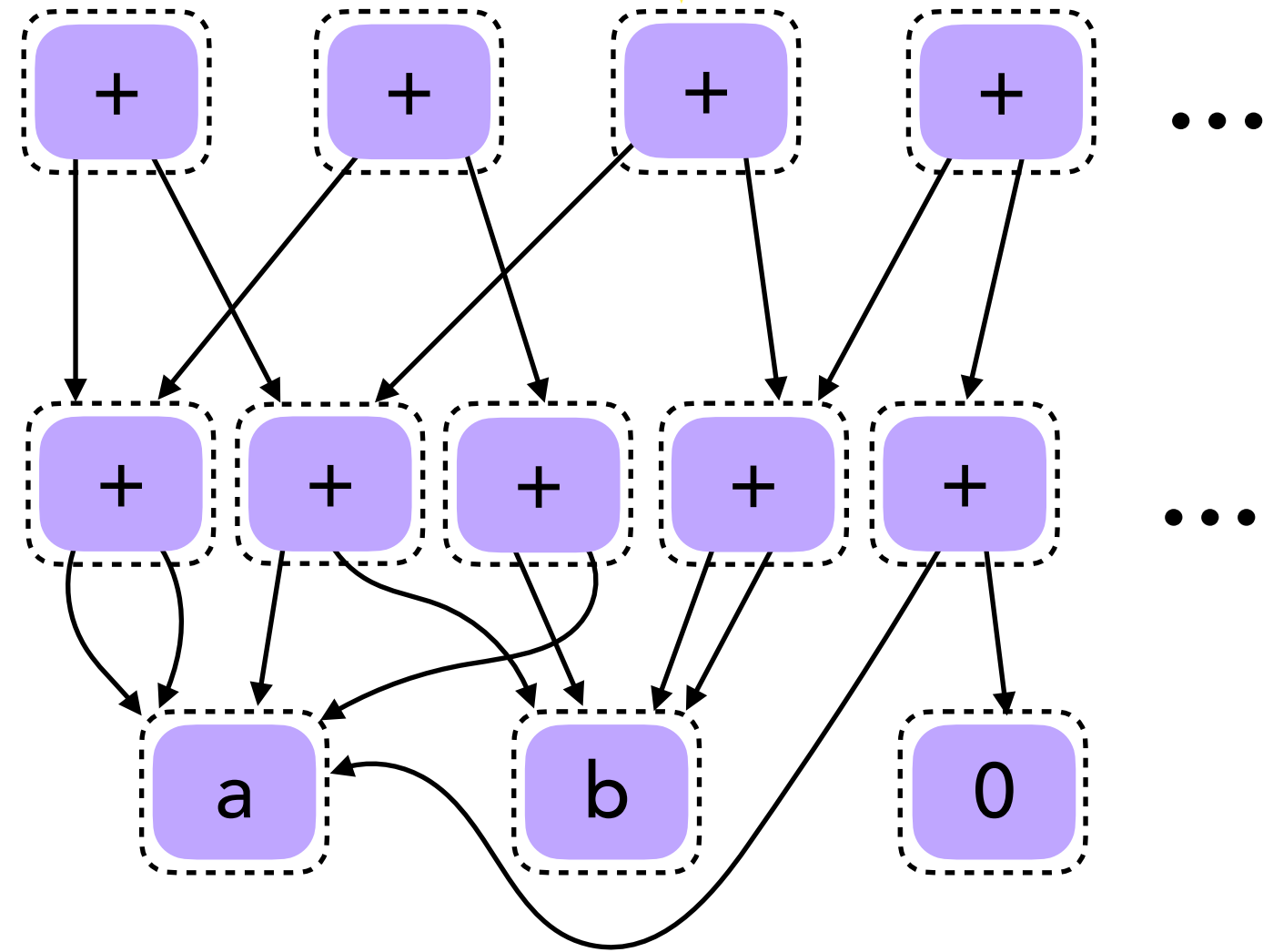

Enumerate over
an E-graph

Enumeration Modulo Equality Saturation

$a, b, 0, +, \dots$

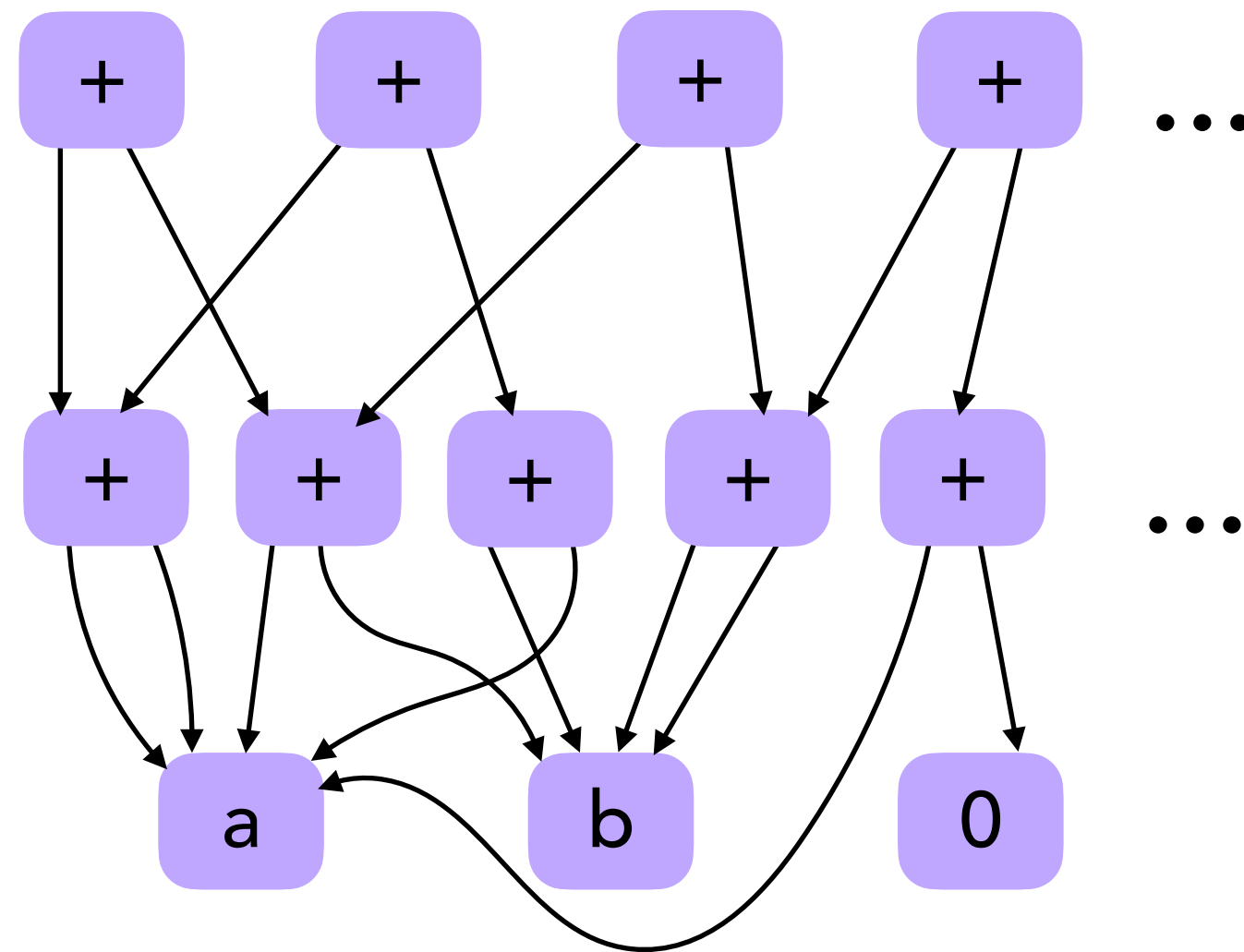

Exponentially
many terms!

E-classes

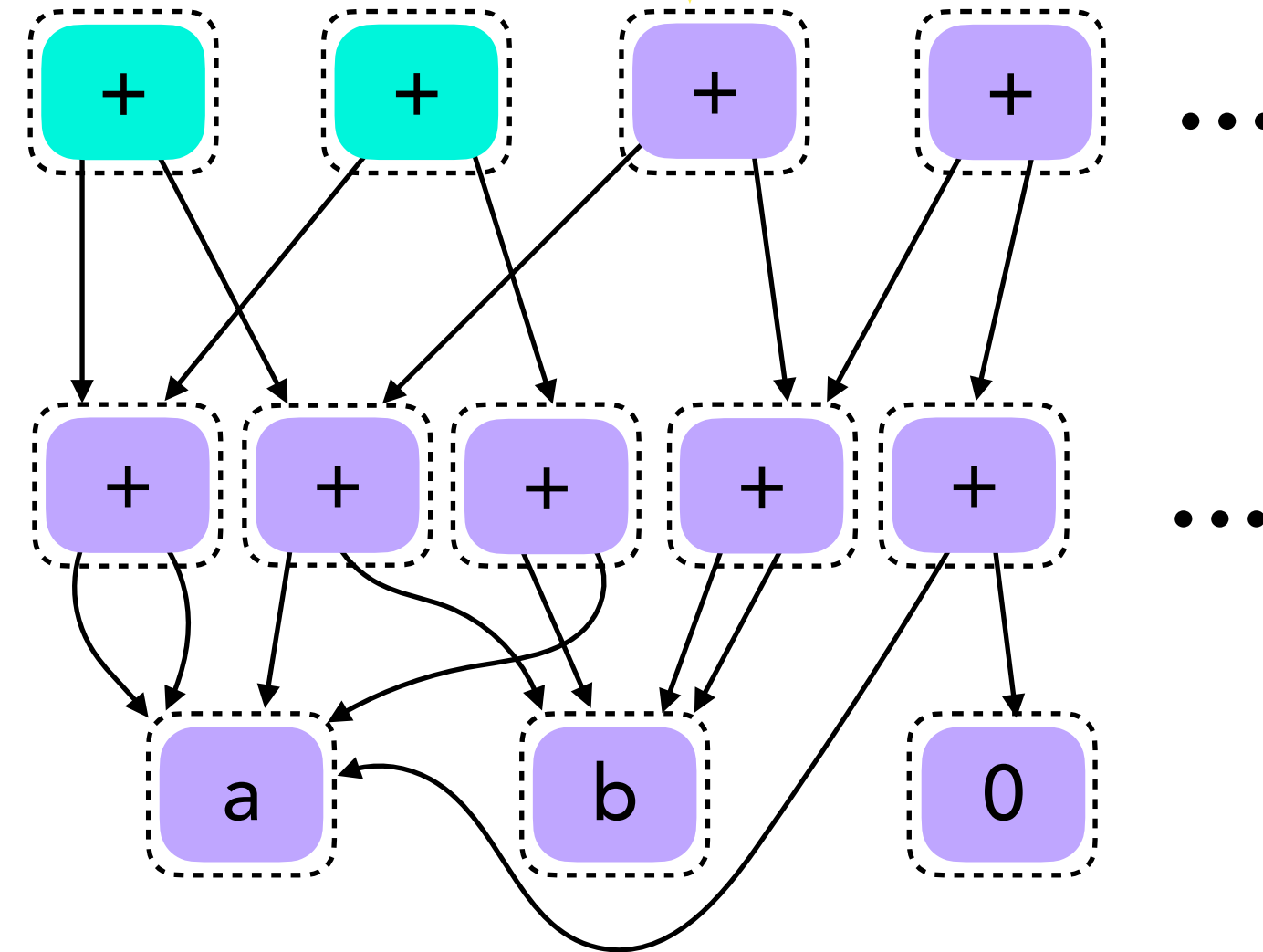

Enumerate over
an E-graph

$$(x + x) + (x + y)$$

\equiv

$$(x + x) + (y + x)$$



Apply current ruleset

$$(x + y) \longleftrightarrow (y + x)$$

Enumeration Modulo Equality Saturation

$a, b, 0, +, \dots$

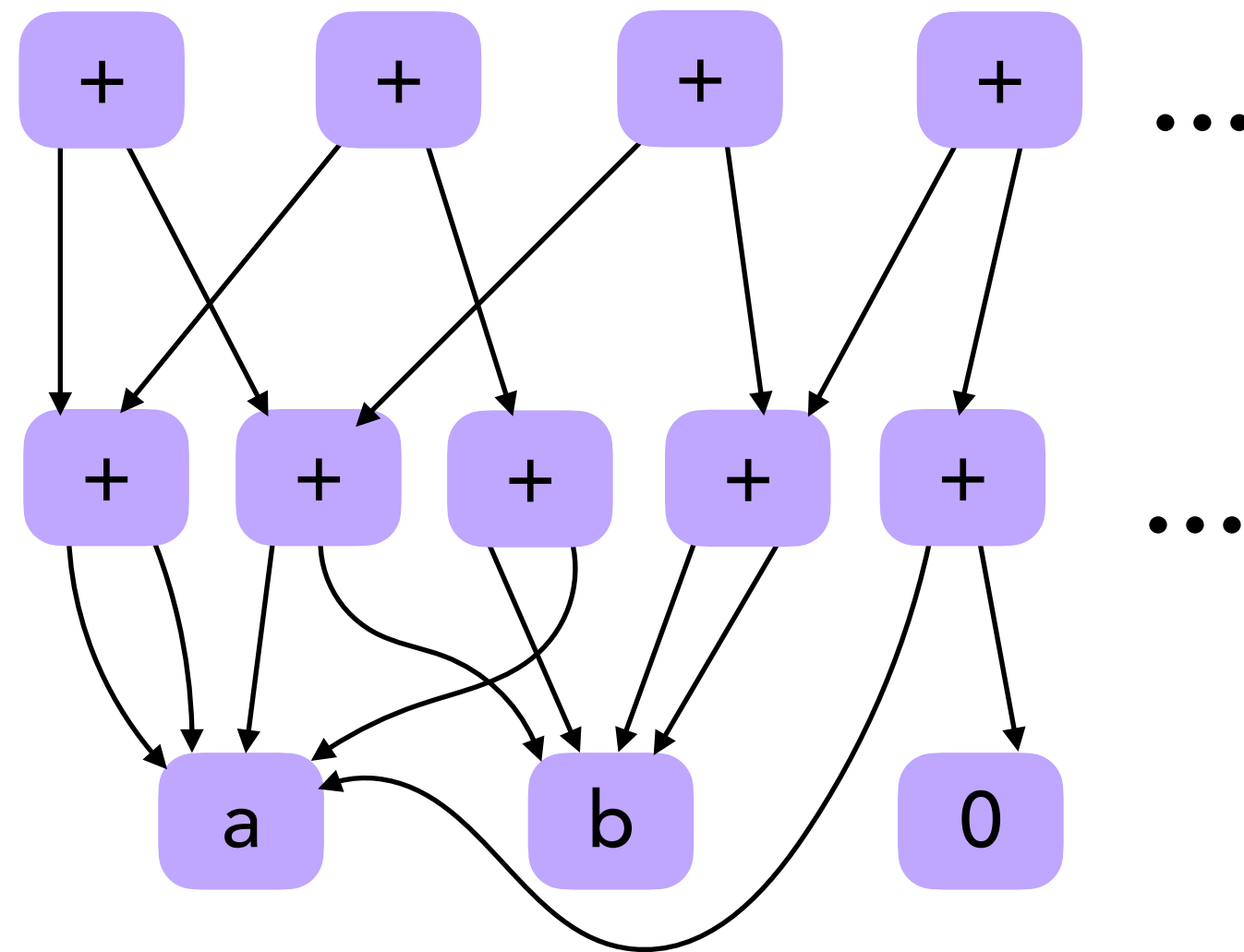

Exponentially
many terms!

E-classes

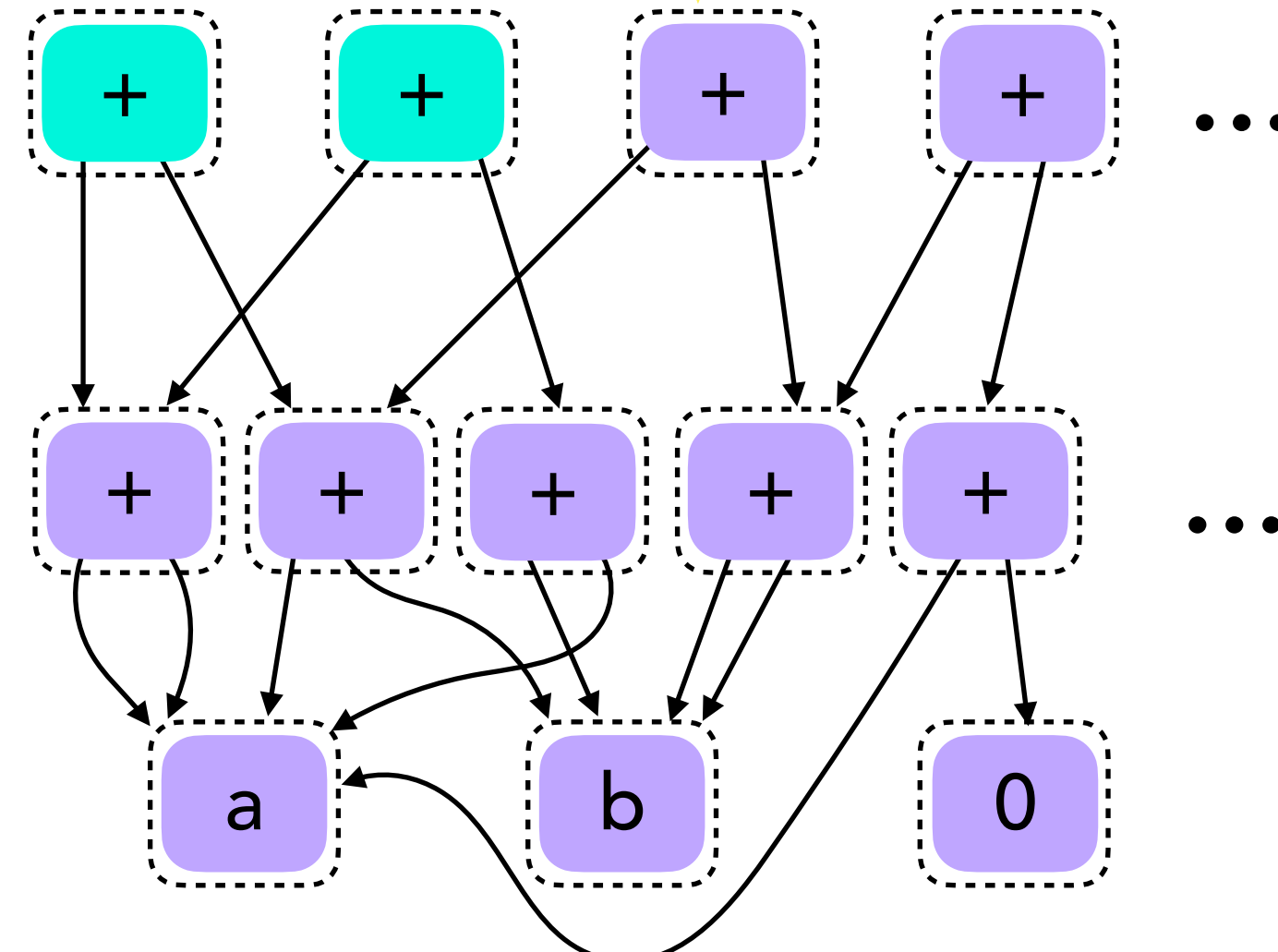

Enumerate over
an E-graph

Merge equivalent terms

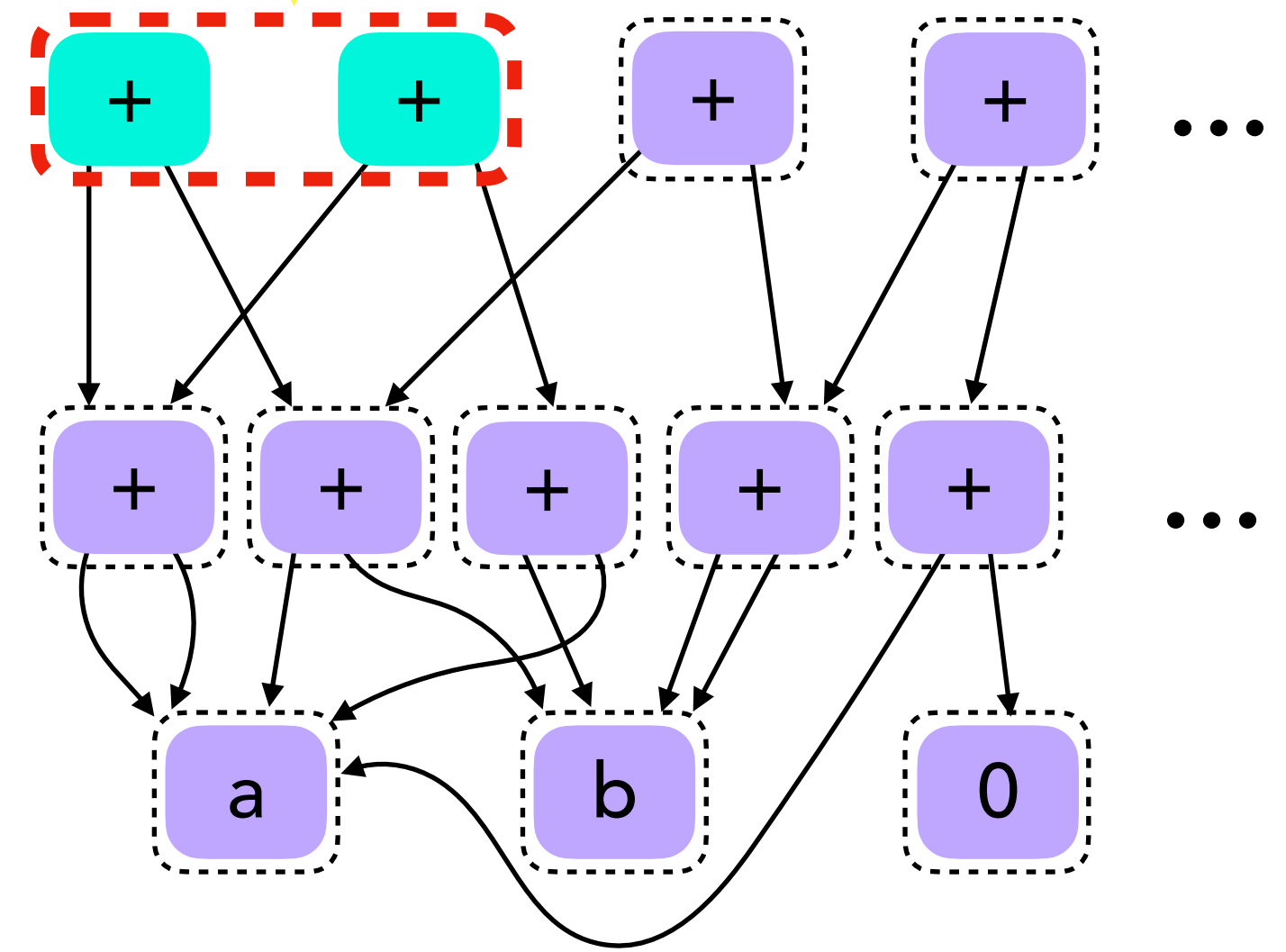

Apply current ruleset

$(x + y) \longleftrightarrow (y + x)$

Enumeration Modulo Equality Saturation

Shrinks the term space by
applying rewrites as they are
learned!

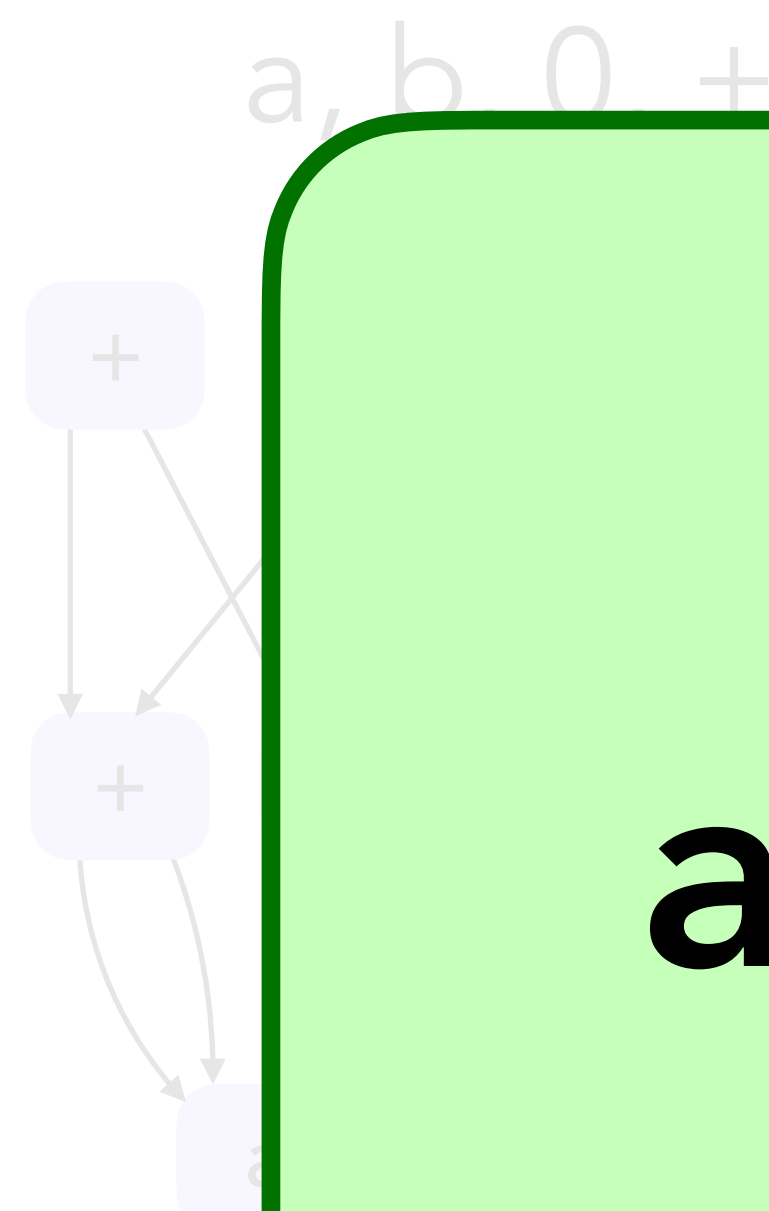

E-classes

Merge equivalent terms

many terms!

an E-graph

$(x + y) \leftrightarrow (y + x)$

Ruler

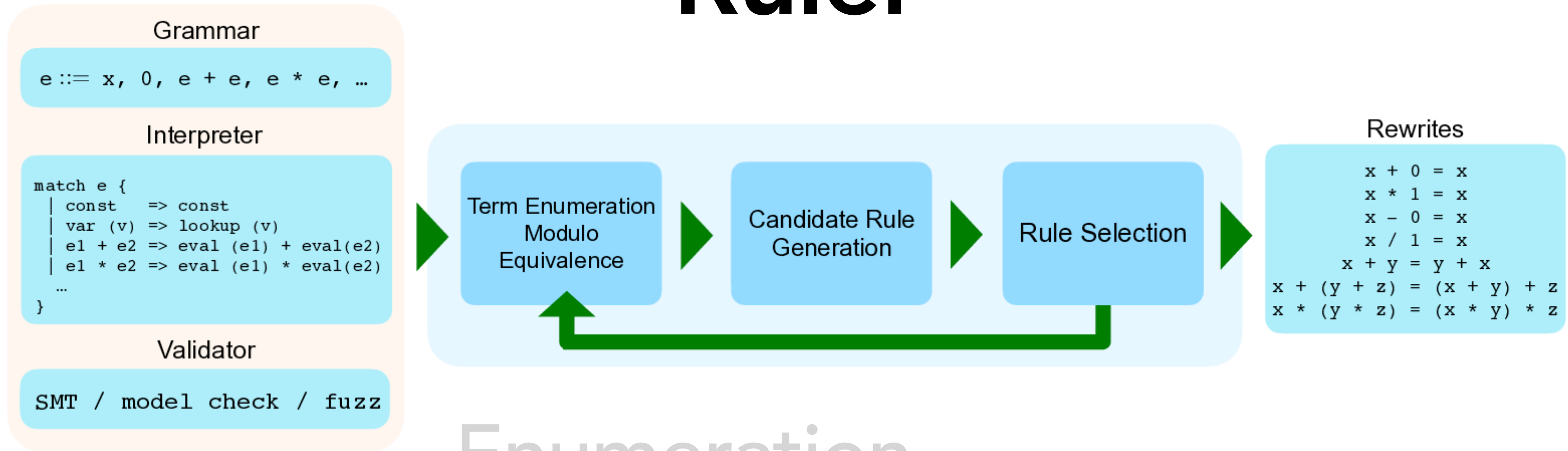

Enumeration

Candidate Generation

Rule Selection

Candidate Generation by Characteristic Vector Matching

a b 0

1
-2
7
4

3
5
-7
-5

0
0
0
0

Seed initial E-classes with
concrete values (cvecs) from the
domain

Candidate Generation by Characteristic Vector Matching

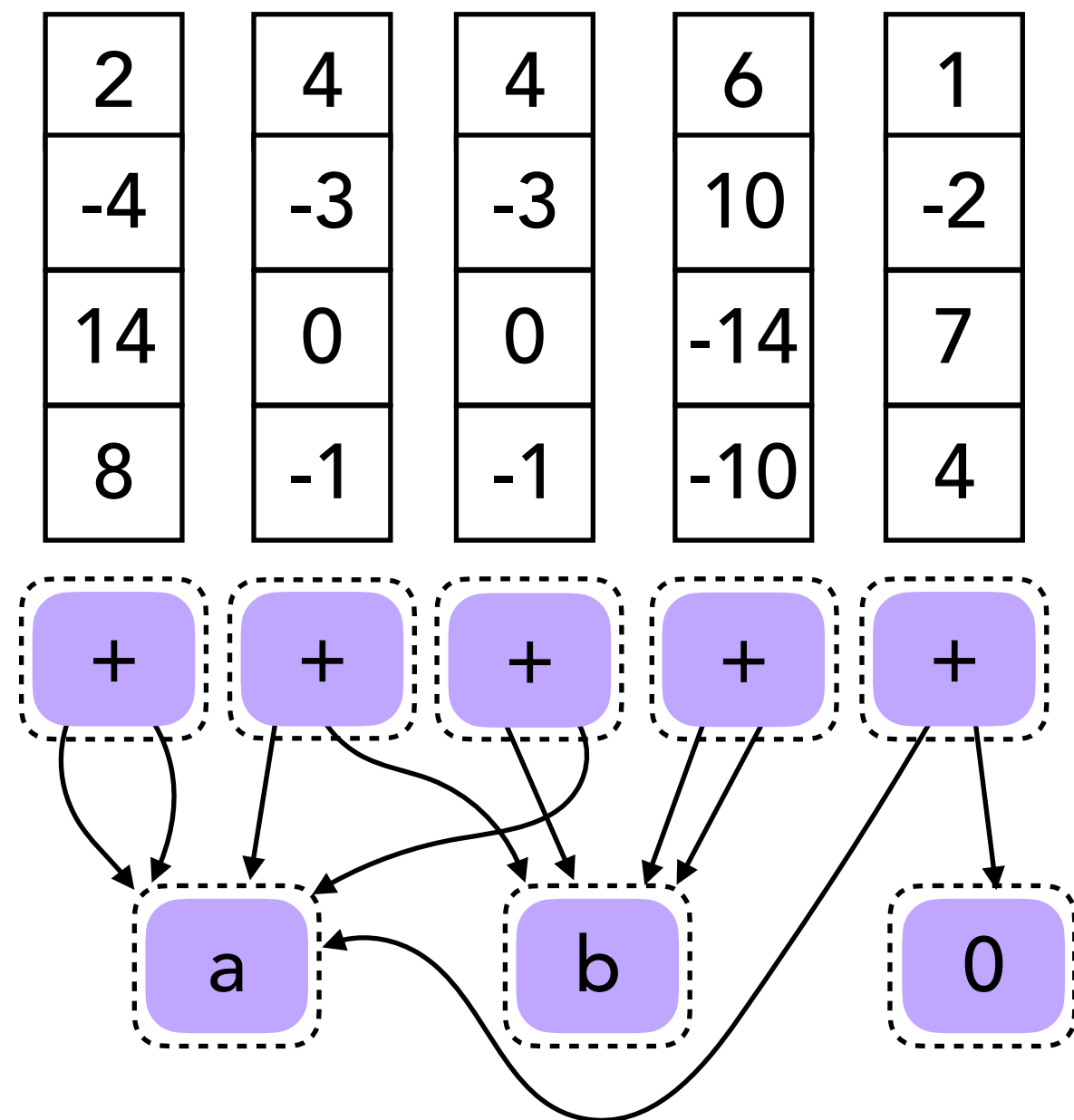

Compute the cvecs for newly enumerated E-classes

Seed initial E-classes with concrete values (cvecs) from the domain

Candidate Generation by Characteristic Vector Matching

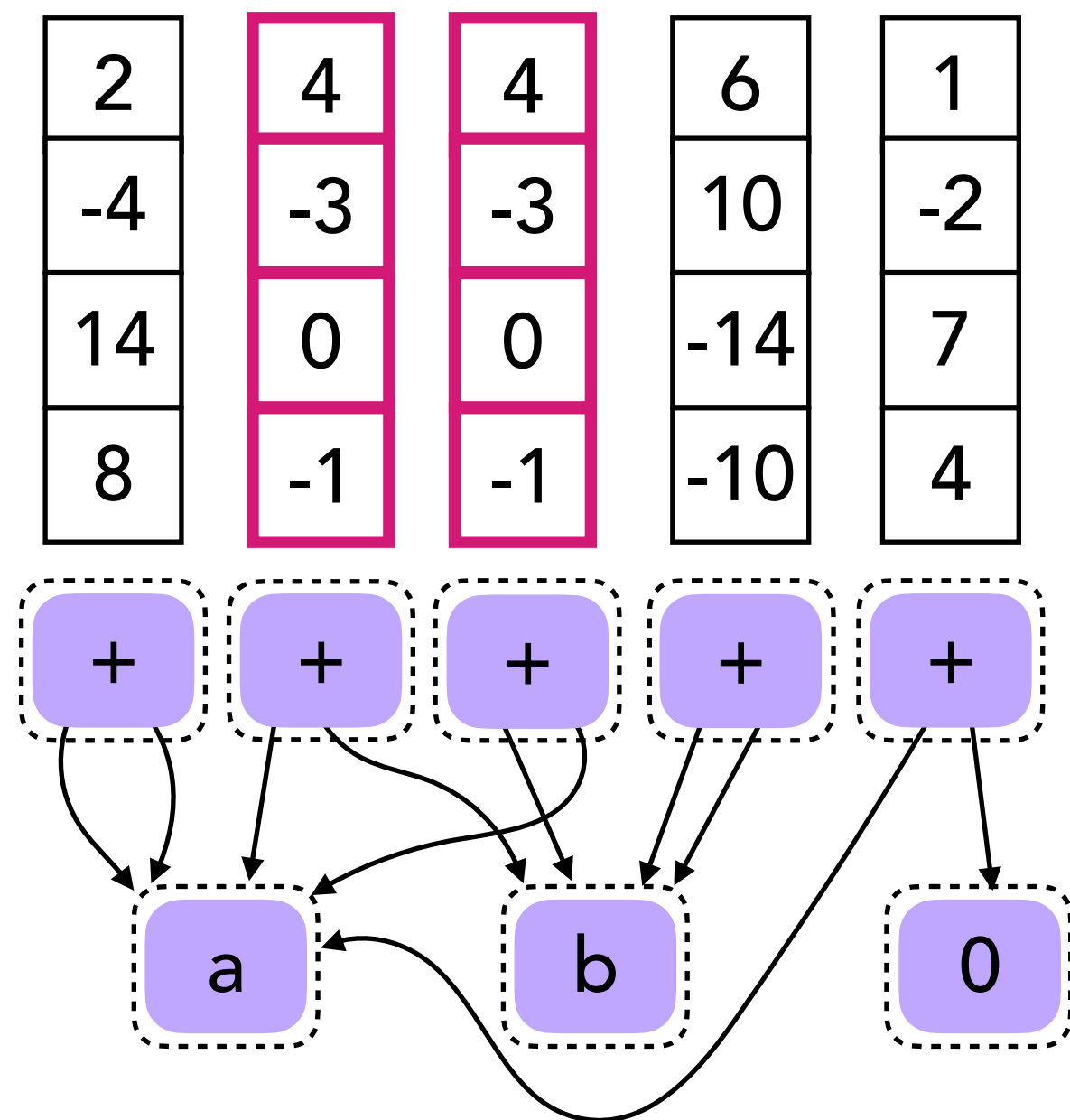

Compute the cvecs for newly enumerated E-classes

$$(x + y) \leftrightarrow (y + x)$$

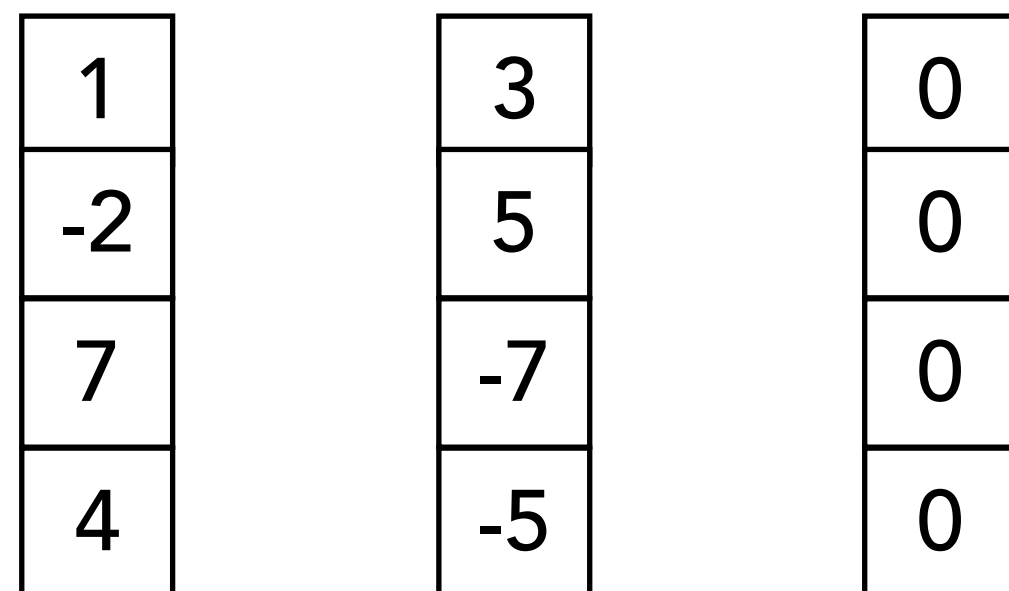

Seed initial E-classes with concrete values (cvecs) from the domain

Candidate Generation by Characteristic Vector Matching

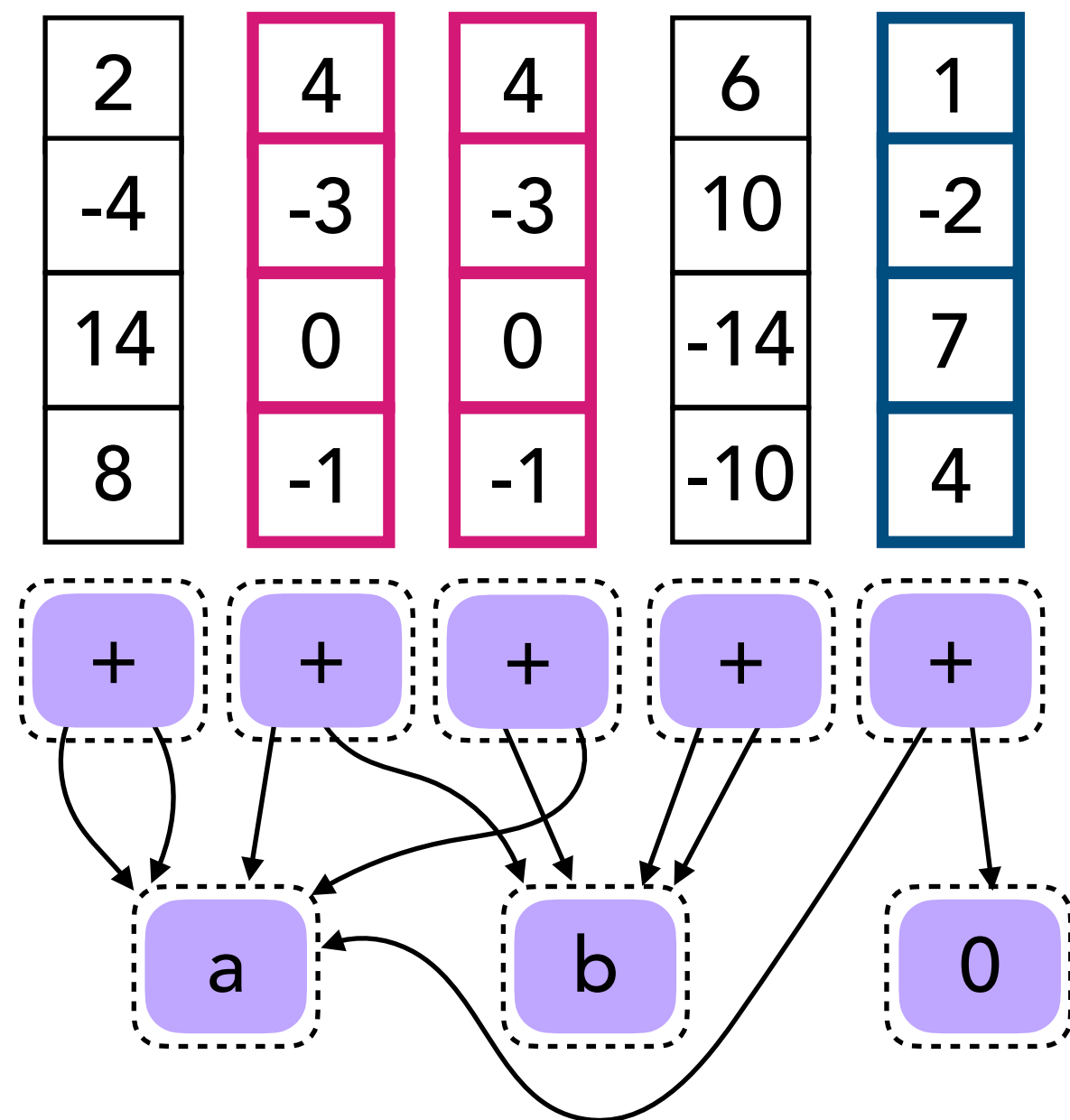

Compute the cvecs for newly enumerated E-classes

$$(x + y) \leftrightarrow (y + x)$$
$$(x + 0) \leftrightarrow x$$

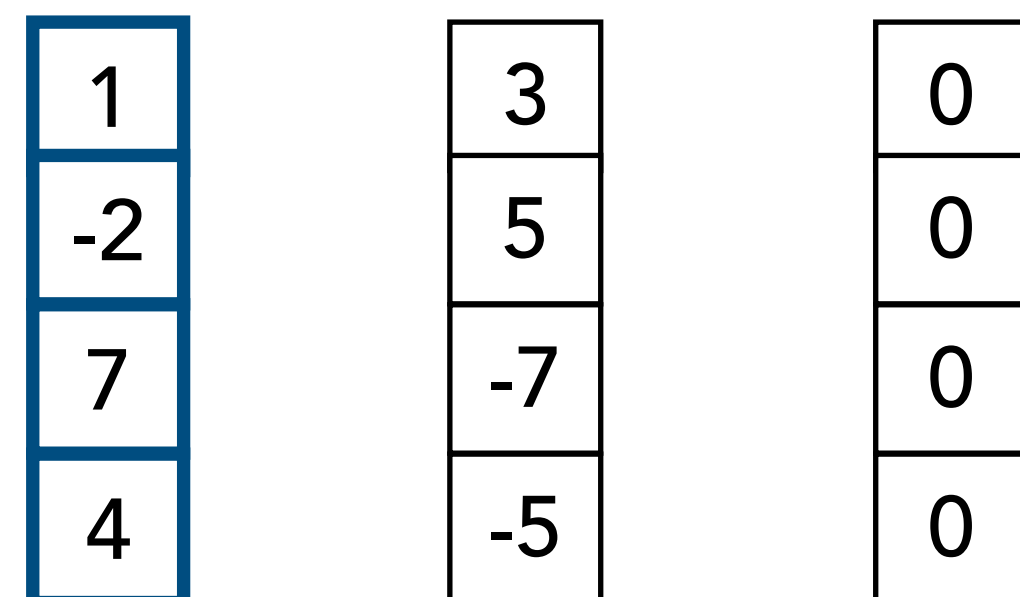

Seed initial E-classes with concrete values (cvecs) from the domain

Candidate Generation by Characteristic Vector Matching

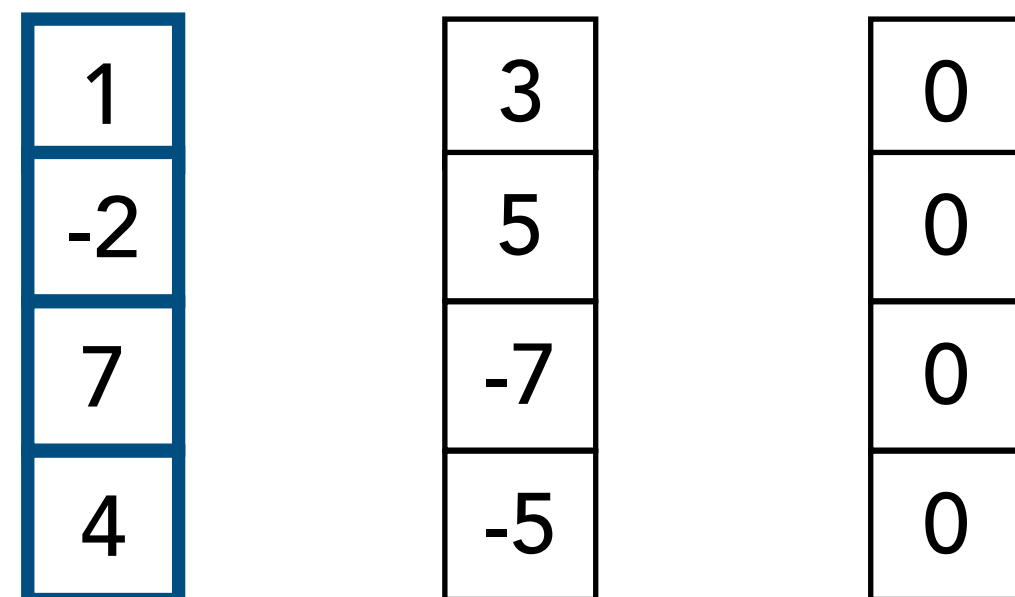
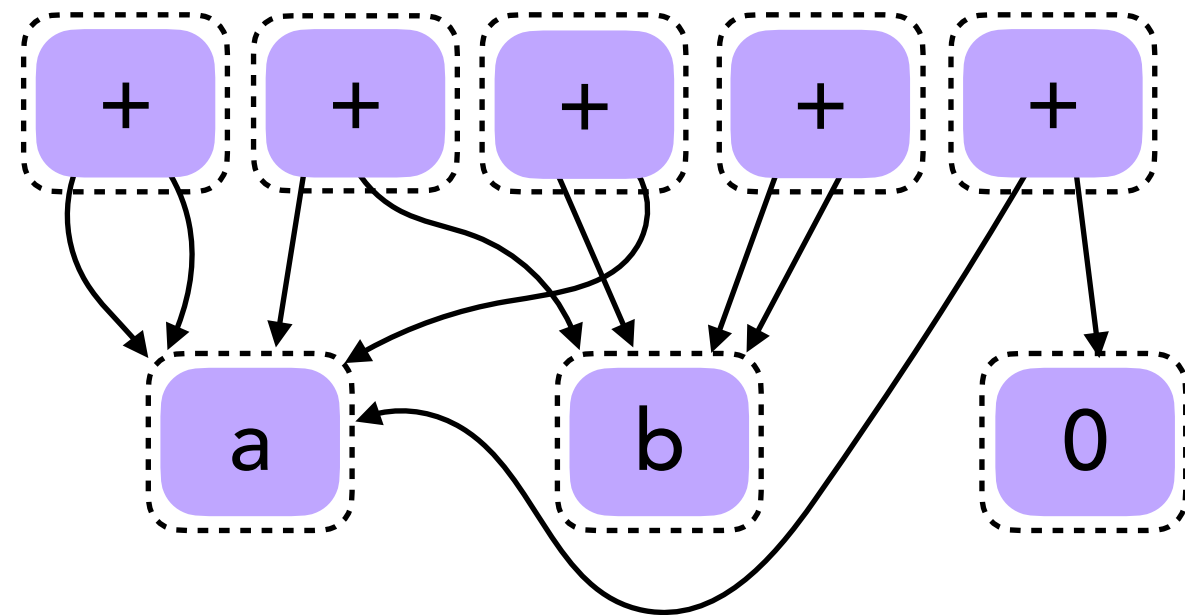
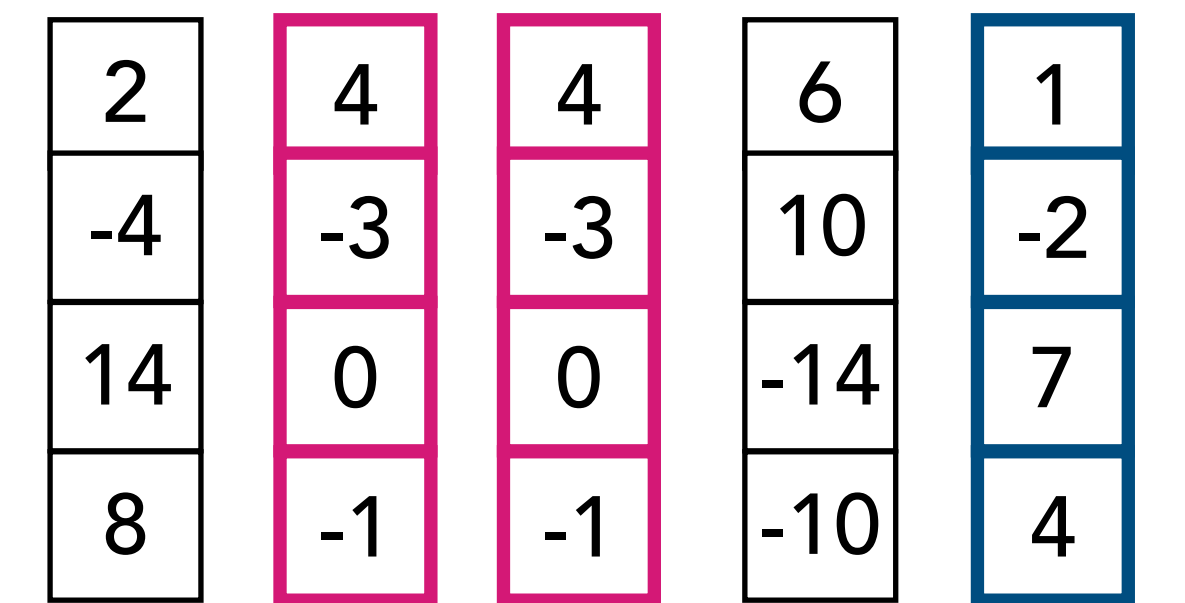

Compute the cvecs for newly enumerated E-classes

Seed initial E-classes with concrete values (cvecs) from the domain

$$(x + y) \leftrightarrow (y + x)$$
$$(x + 0) \leftrightarrow x$$

Validate candidates using SMT, fuzzing, model checking

Ruler

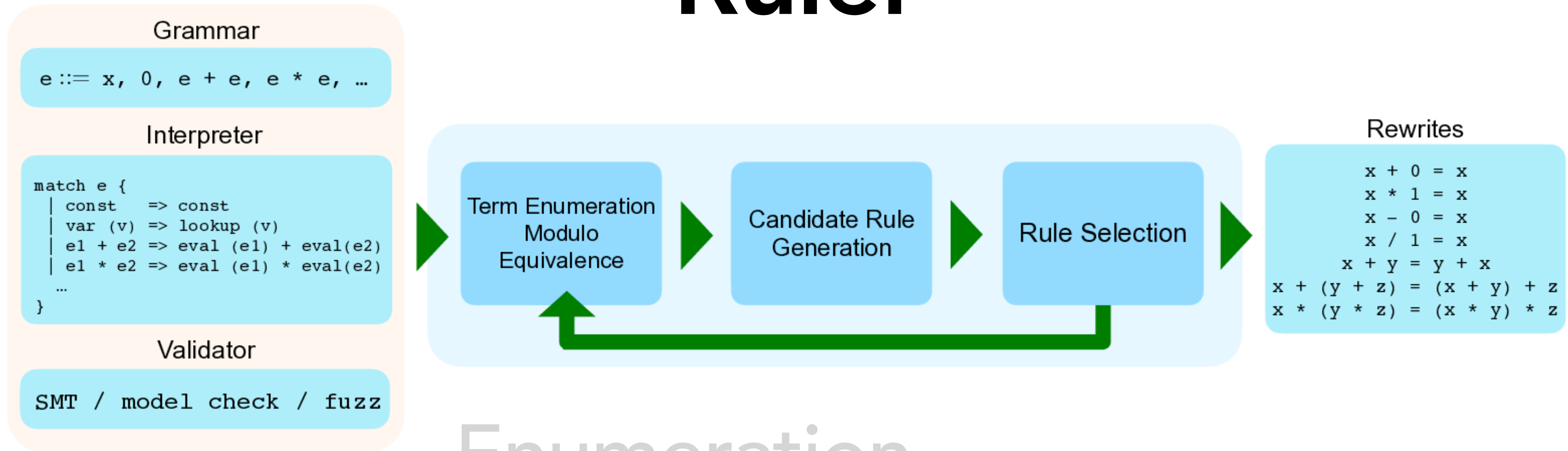

Enumeration

Candidate Generation

Rule Selection

Rule Selection with Equality Saturation

$$(x + y) \iff (y + x)$$

$$(x + 0) \iff (0 + x)$$

$$(y + 0) \iff (0 + y)$$

$$(x * y) \iff (y * x)$$

$$(x * 1) \iff (1 * x)$$

$$(y * 1) \iff (1 * y)$$

C =

Rule Selection with Equality Saturation

Rank sound candidates based on generality and pick top-k (2)

$$(x + y) \iff (y + x)$$

$$(x * y) \iff (y * x)$$

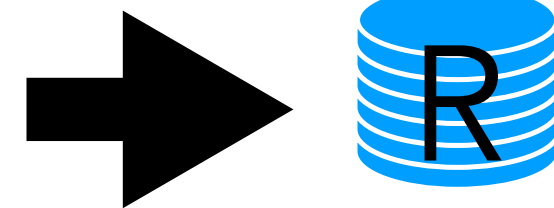

$$(x + 0) \iff (0 + x)$$

$$(y + 0) \iff (0 + y)$$

$$(x * 1) \iff (1 * x)$$

$$(y * 1) \iff (1 * y)$$

C =

Rule Selection with Equality Saturation

Rank sound candidates based on generality and pick top-k (2)

$$(x + y) \iff (y + x)$$

$$(x * y) \iff (y * x)$$

$$(x + 0) \iff (0 + x)$$

$$(y + 0) \iff (0 + y)$$

$$(x * 1) \iff (1 * x)$$

$$(y * 1) \iff (1 * y)$$

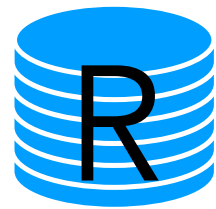

Instantiate and add to rule E-graph



Rule Selection with Equality Saturation

Rank sound candidates based on generality and pick top-k (2)

$$(x + y) \iff (y + x)$$

$$(x * y) \iff (y * x)$$

$$(x + 0) \iff (0 + x)$$

$$(y + 0) \iff (0 + y)$$

$$(x * 1) \iff (1 * x)$$

$$(y * 1) \iff (1 * y)$$

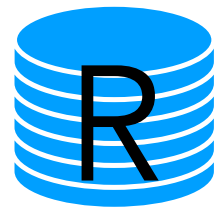

Instantiate and add to rule E-graph

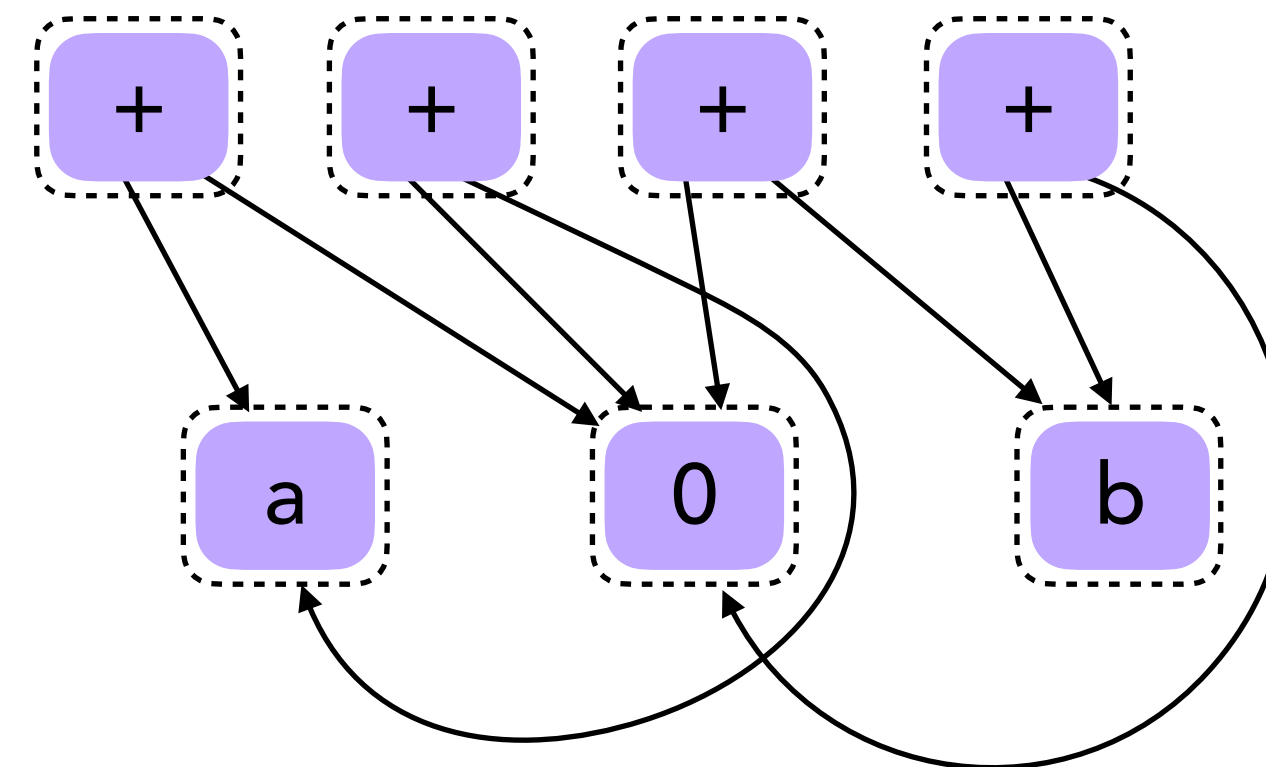

Rule Selection with Equality Saturation

Rank sound candidates based on generality and pick top-k (2)

$$(x + y) \iff (y + x)$$

$$(x * y) \iff (y * x)$$

$$(x + 0) \iff (0 + x)$$

$$(y + 0) \iff (0 + y)$$

$$(x * 1) \iff (1 * x)$$

$$(y * 1) \iff (1 * y)$$

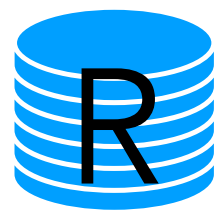

Instantiate and add to rule E-graph

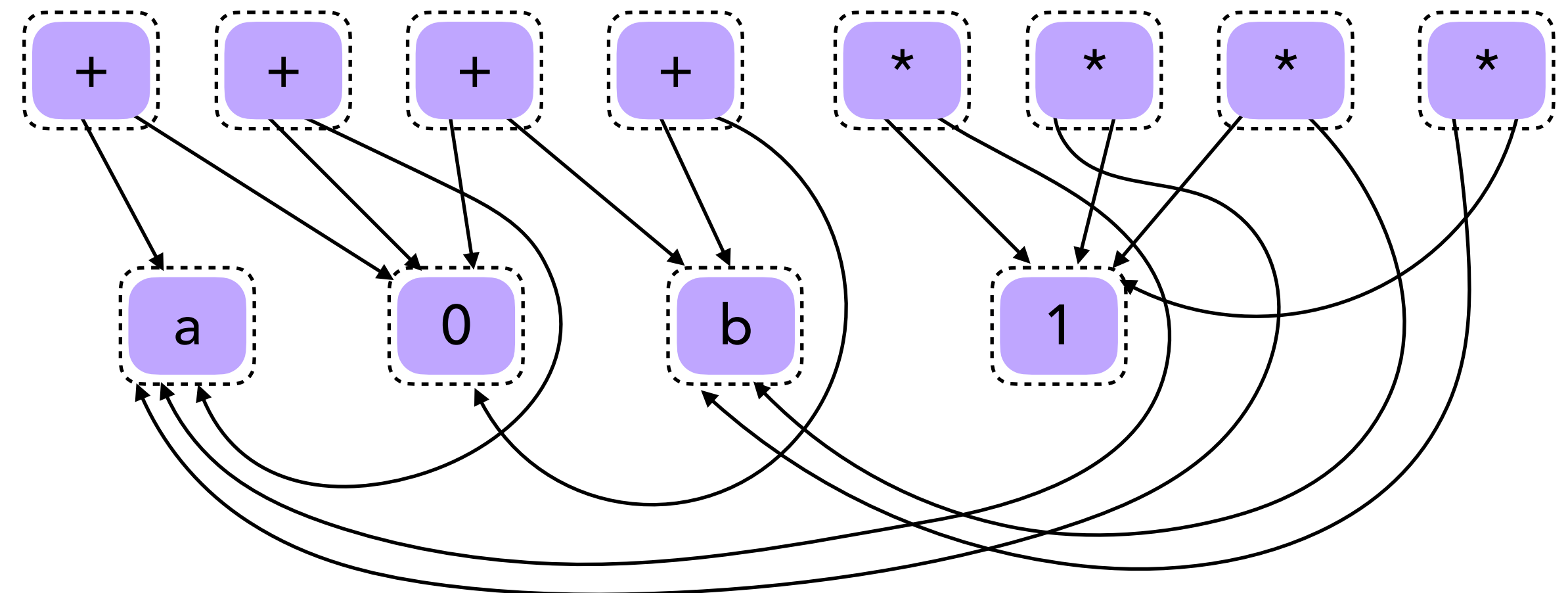

Rule Selection with Equality Saturation

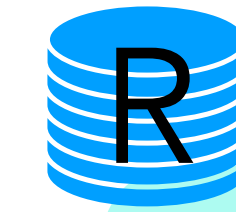

$(x + y) \leftrightarrow (y + x)$
 $(x * y) \leftrightarrow (y * x)$

Run equality saturation

$(x + 0) \leftrightarrow (0 + x)$
 $(y + 0) \leftrightarrow (0 + y)$
 $(x * 1) \leftrightarrow (1 * x)$
 $(y * 1) \leftrightarrow (1 * y)$

Instantiate and add to rule E-graph

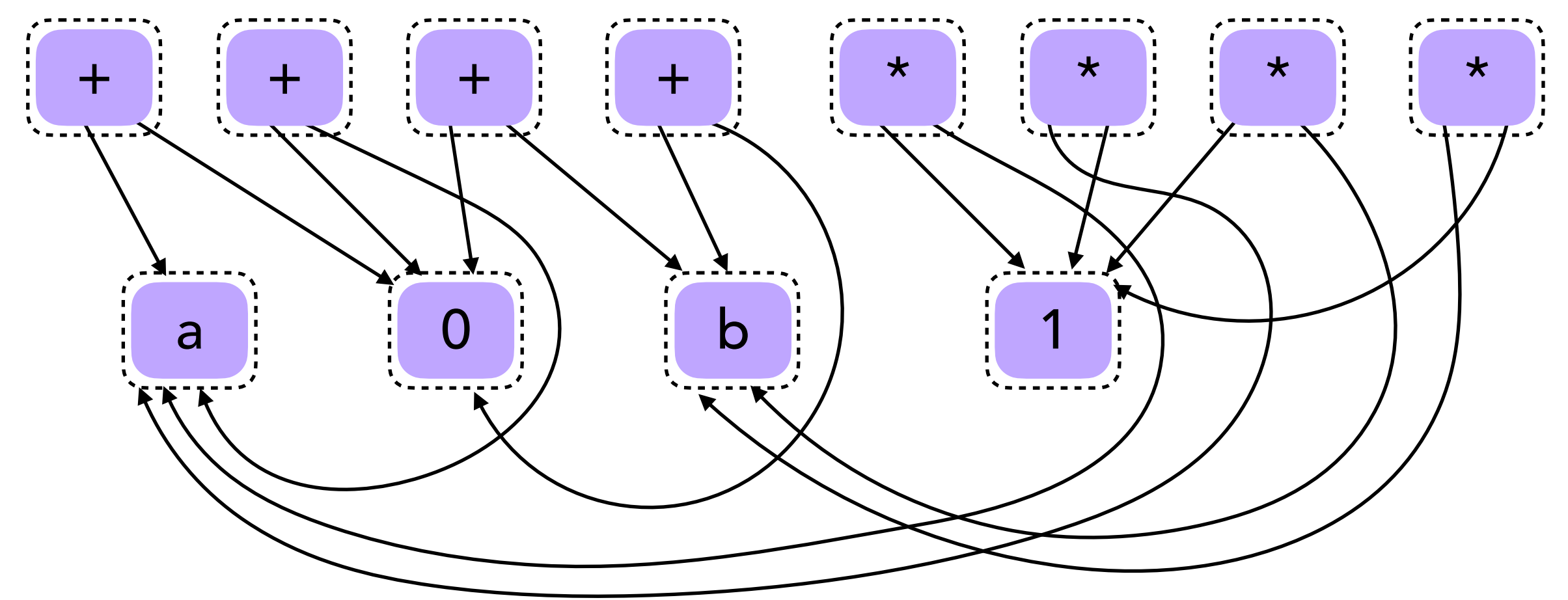

Rule Selection with Equality Saturation

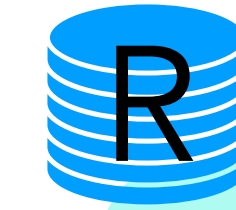

$$\begin{aligned} (x + y) &\leftrightarrow (y + x) \\ (x * y) &\leftrightarrow (y * x) \end{aligned}$$

All four rules are redundant and therefore discarded!

Run equality saturation

$$\begin{aligned} (x + 0) &\leftrightarrow (0 + x) \\ (y + 0) &\leftrightarrow (0 + y) \\ (x * 1) &\leftrightarrow (1 * x) \\ (y * 1) &\leftrightarrow (1 * y) \end{aligned}$$

Instantiate and add to rule E-graph

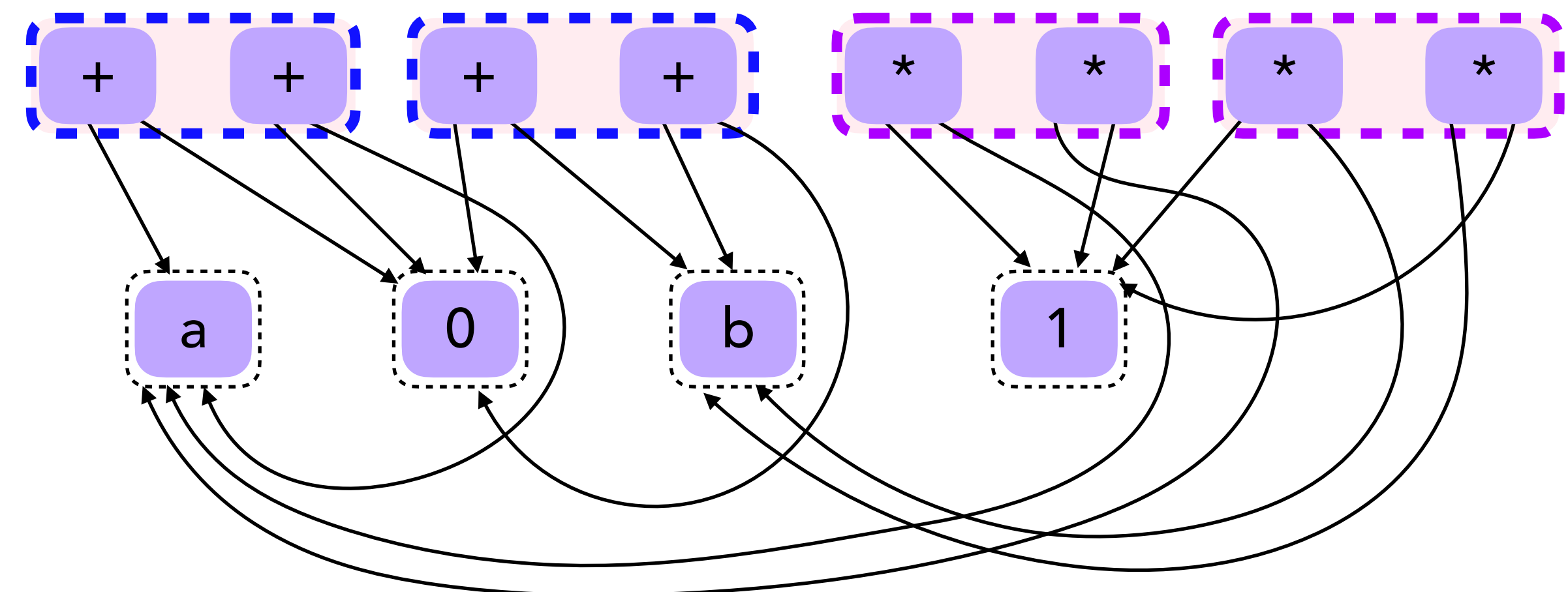

Rule Selection with Equality Saturation

Continue processing until candidate set is empty or has only unsound ones left!

All four rules are redundant and therefore discarded!

R

$$\begin{aligned} (x + y) &\leftrightarrow (y + x) \\ (x * y) &\leftrightarrow (y * x) \end{aligned}$$

Run equality saturation

$$\begin{aligned} (x + 0) &\leftrightarrow (0 + x) \\ (y + 0) &\leftrightarrow (0 + y) \\ (x * 1) &\leftrightarrow (1 * x) \\ (y * 1) &\leftrightarrow (1 * y) \end{aligned}$$

Instantiate and add to rule E-graph

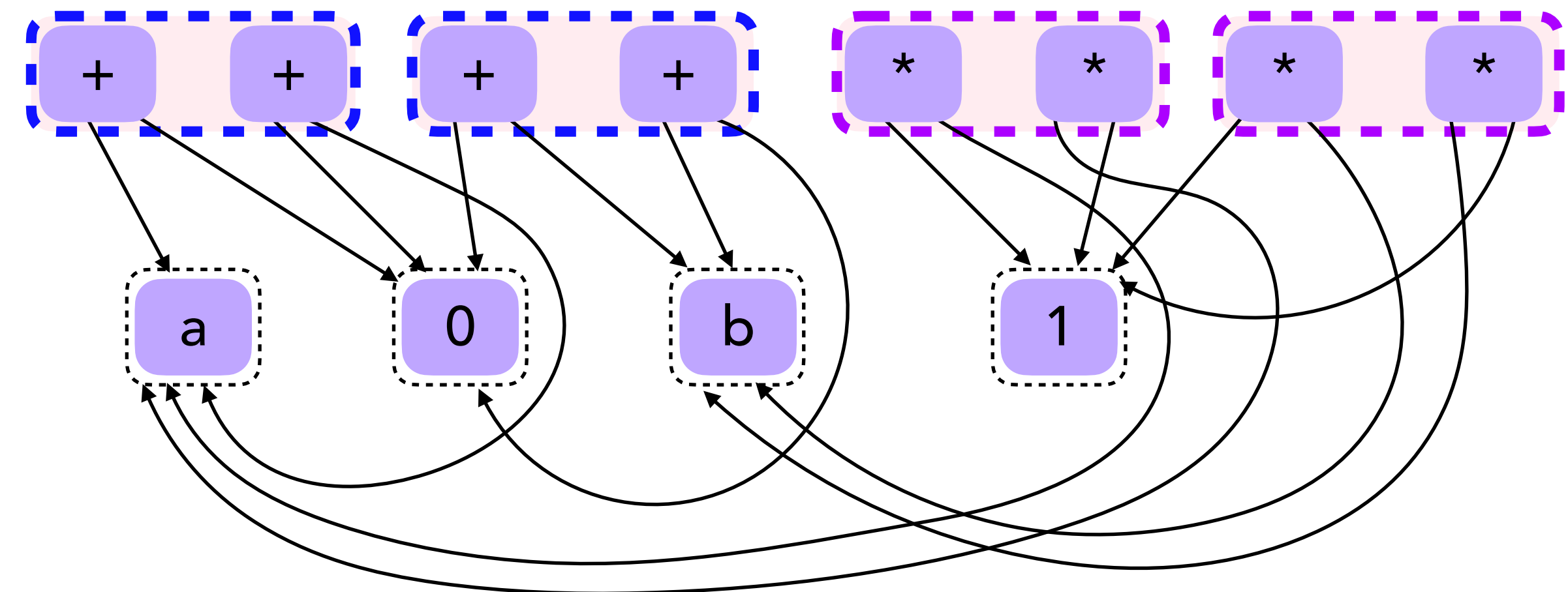

Rule Selection with Equality Saturation

Larger top-k makes Ruler faster

Smaller top-k gives smaller rulesets

See paper for detailed comparison!

\mathbb{R}

$$(x + y) \leftrightarrow (y + x)$$

$$(x * y) \leftrightarrow (y * x)$$

Run equality saturation

$$(x + 0) \leftrightarrow (0 + x)$$

$$(y + 0) \leftrightarrow (0 + y)$$

$$(x * 1) \leftrightarrow (1 * x)$$

$$(y * 1) \leftrightarrow (1 * y)$$

Instantiate and add to rule E-graph

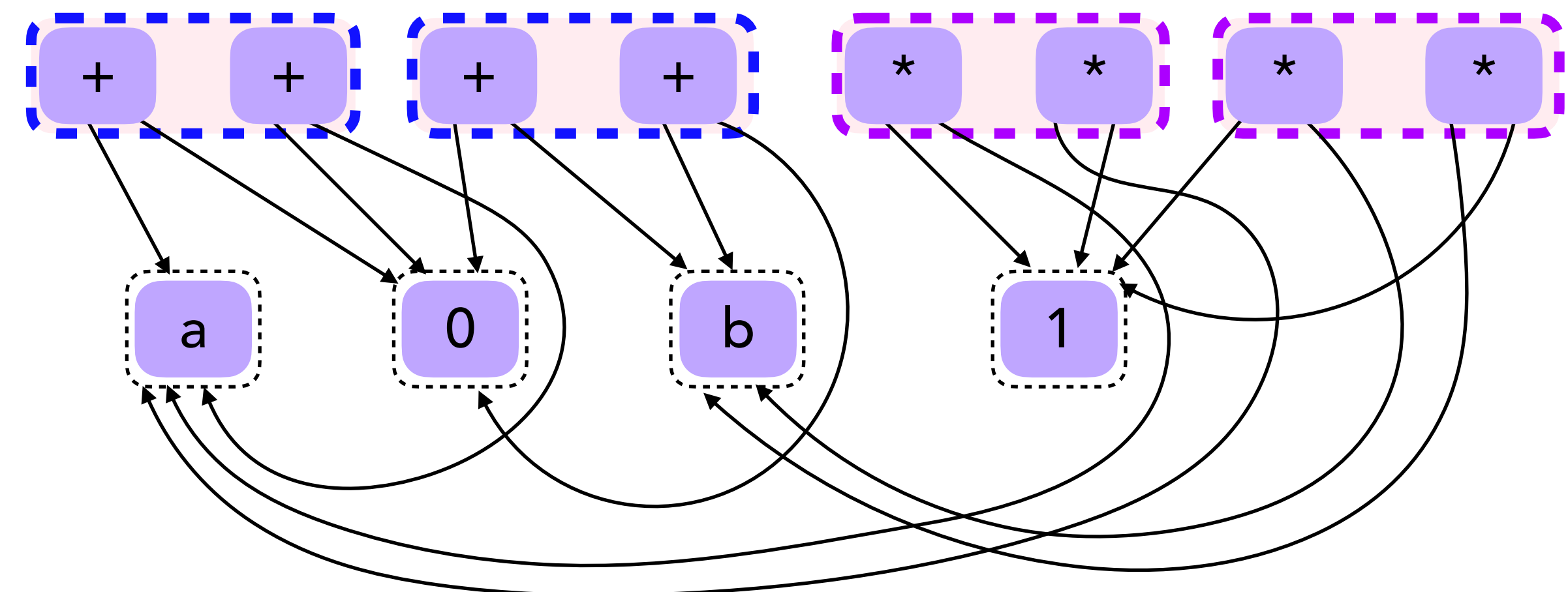

Rule Selection with Equality Saturation

Larger top-k makes Ruler faster

Shrinks the candidate space by
applying rewrites as they are learned!

$(y * 1) \leftrightarrow (1 * y)$

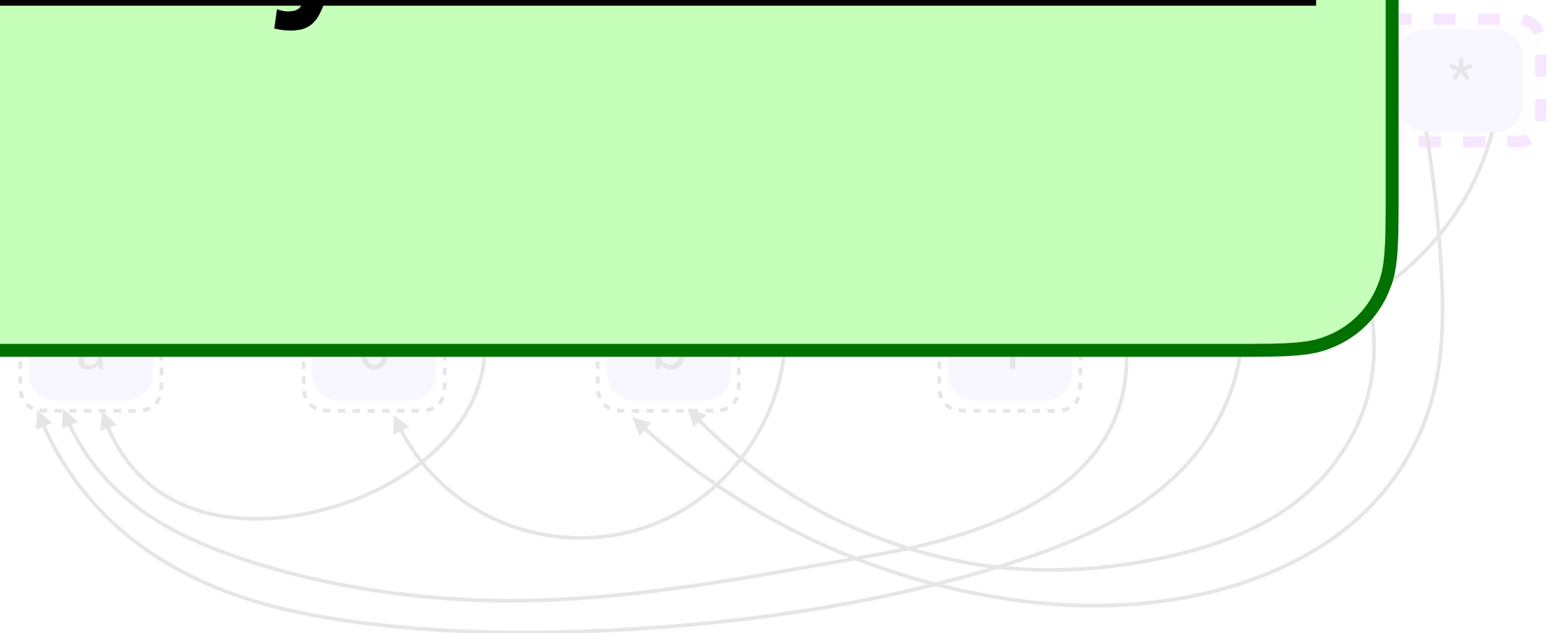
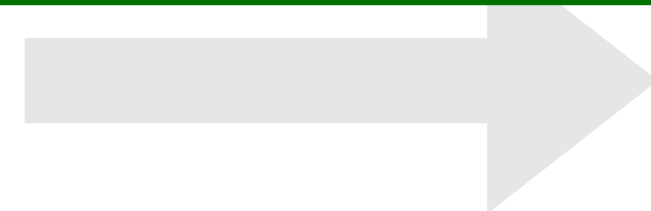

ality
ion

Ruler

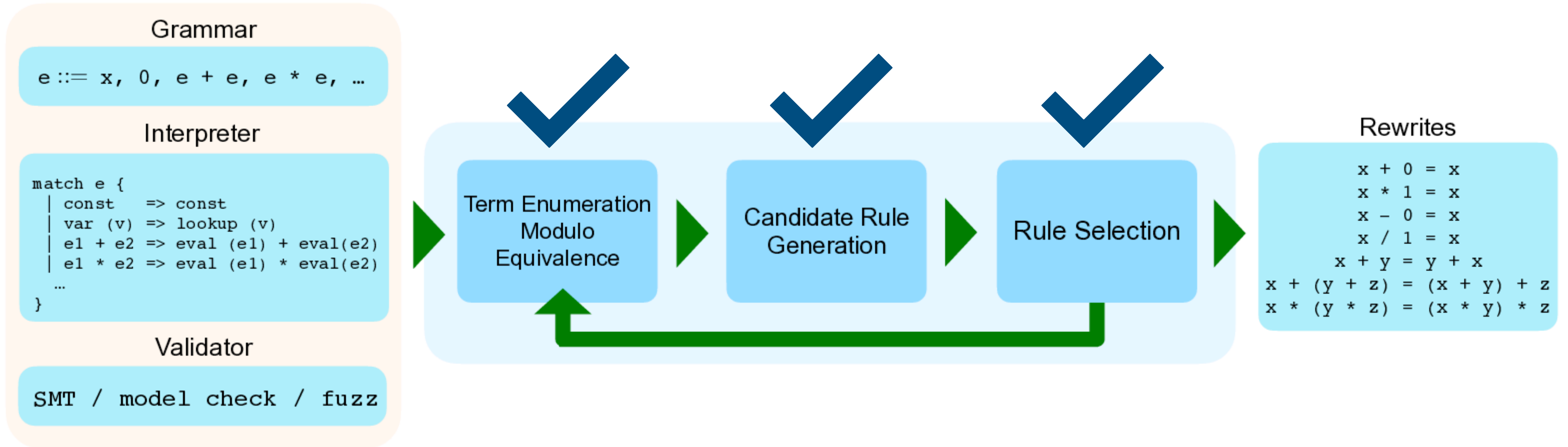

Equality Saturation "*Soundness*"

Equality Saturation *amplifies* unsoundness!

Equality Saturation "*Soundness*"

Equality Saturation *amplifies* unsoundness!

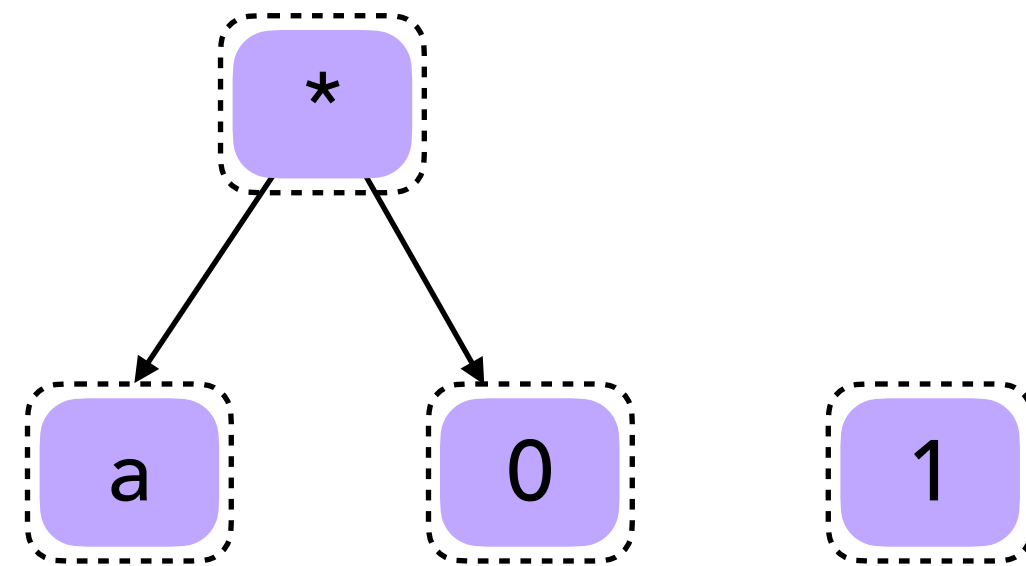

Equality Saturation "Soundness"

Equality Saturation *amplifies* unsoundness!

current
ruleset

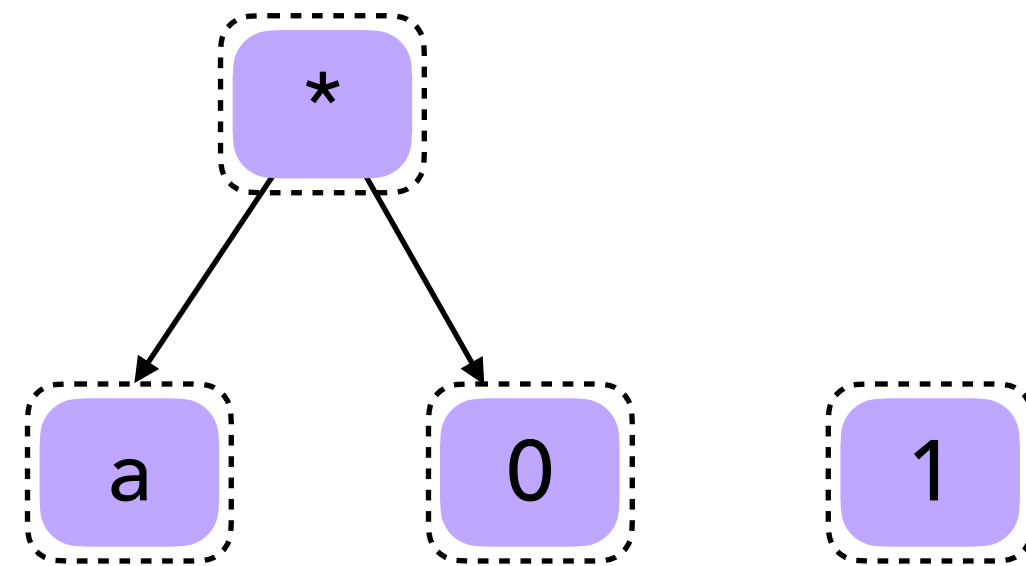

$$(y * 0) \longleftrightarrow 0$$

$$(y * 0) \longleftrightarrow 1$$

Equality Saturation "Soundness"

Equality Saturation *amplifies* unsoundness!

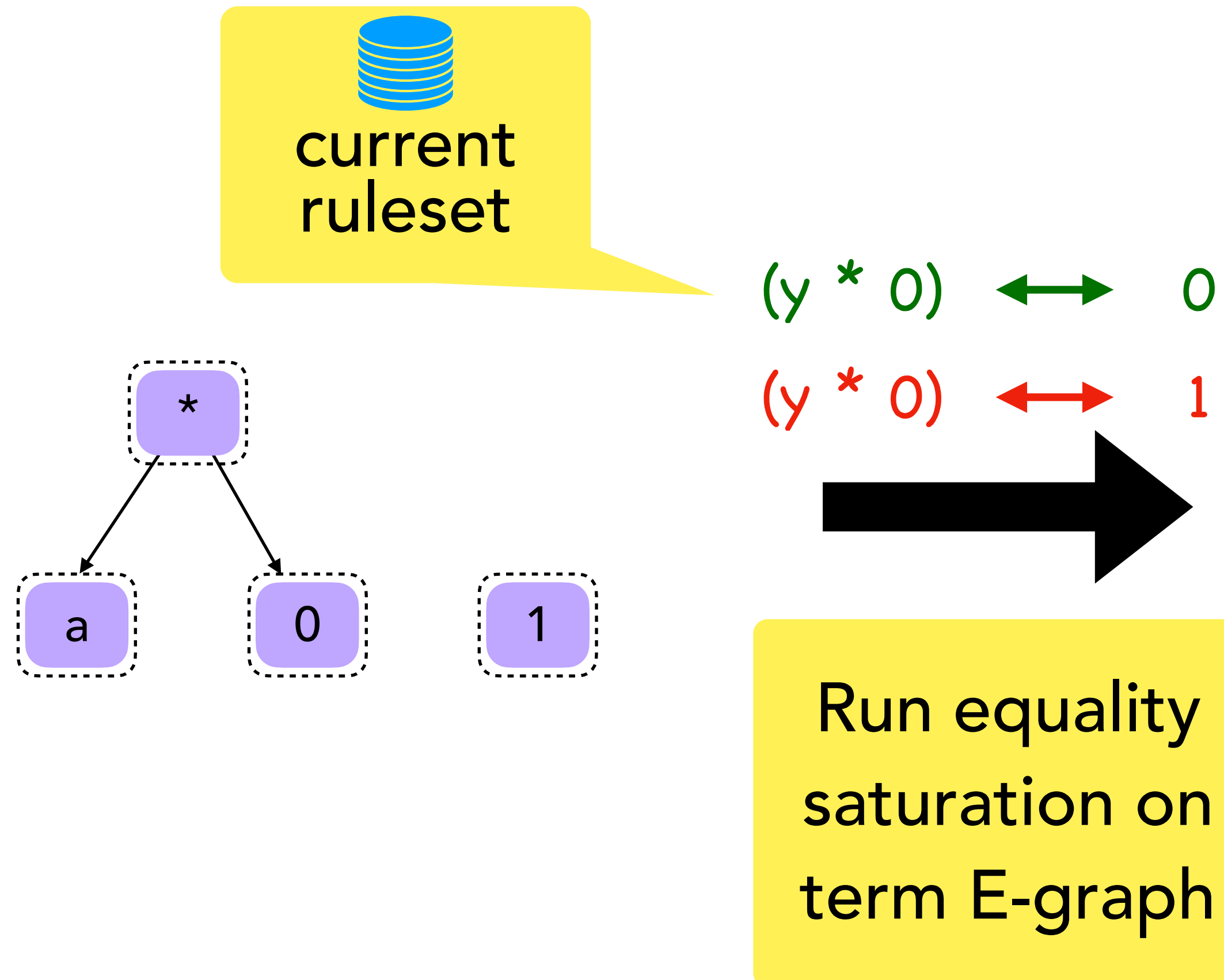

Equality Saturation "Soundness"

Equality Saturation *amplifies* unsoundness!

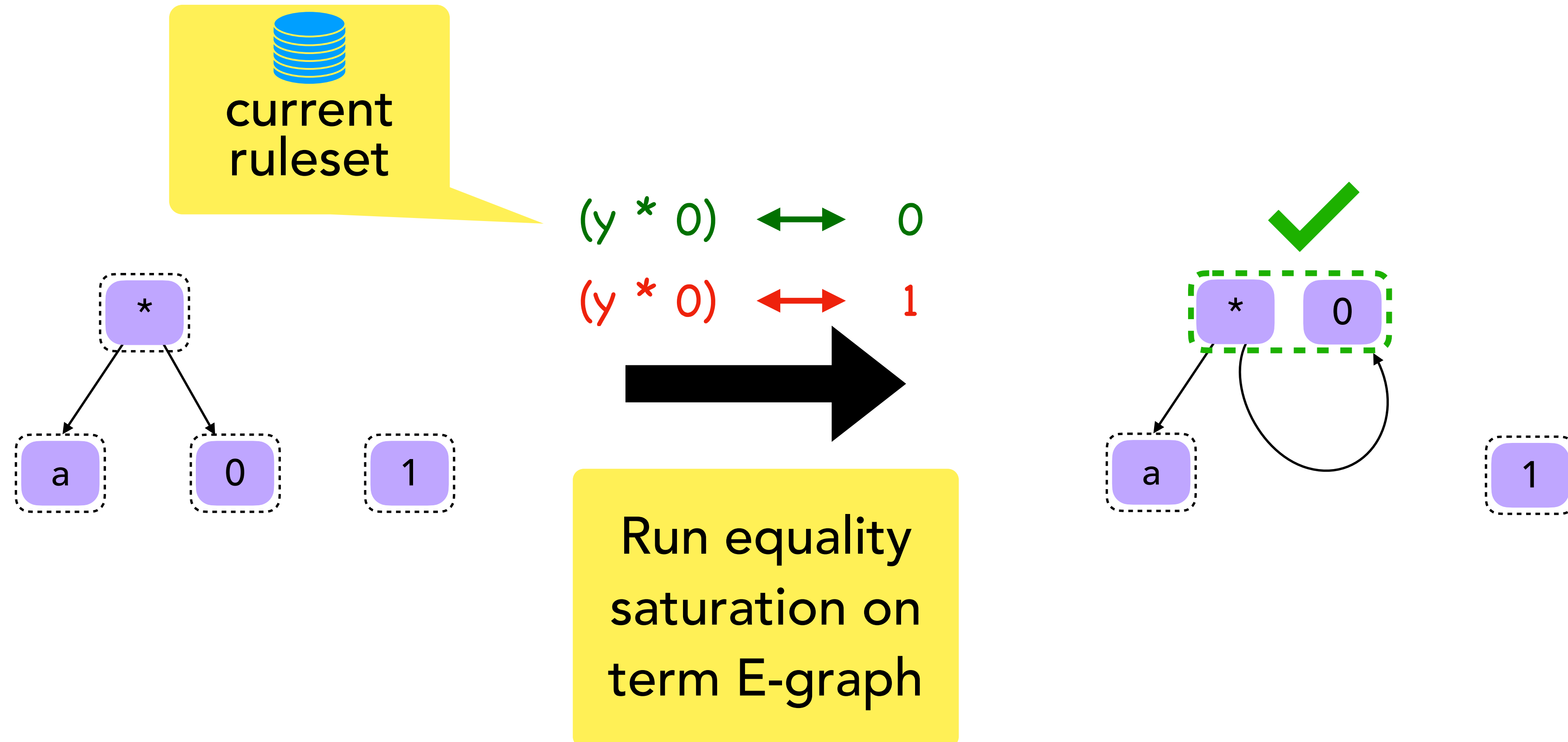

Equality Saturation "Soundness"

Equality Saturation *amplifies* unsoundness!

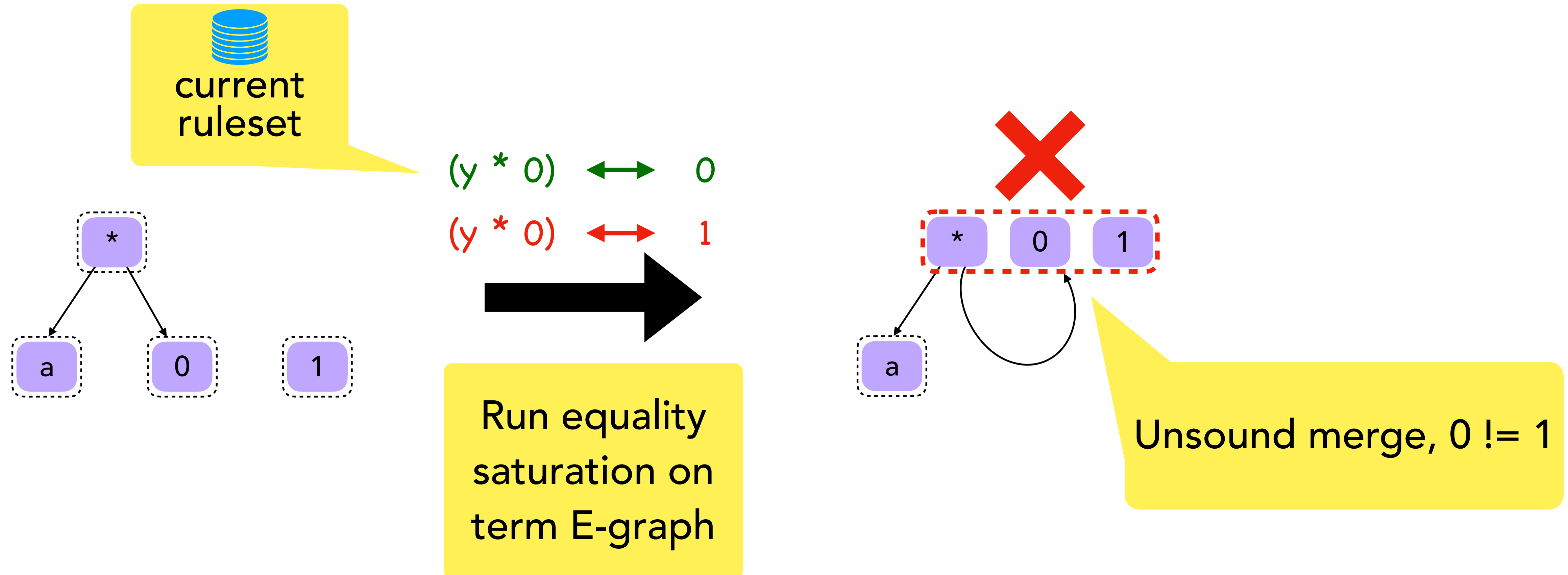

Implementation

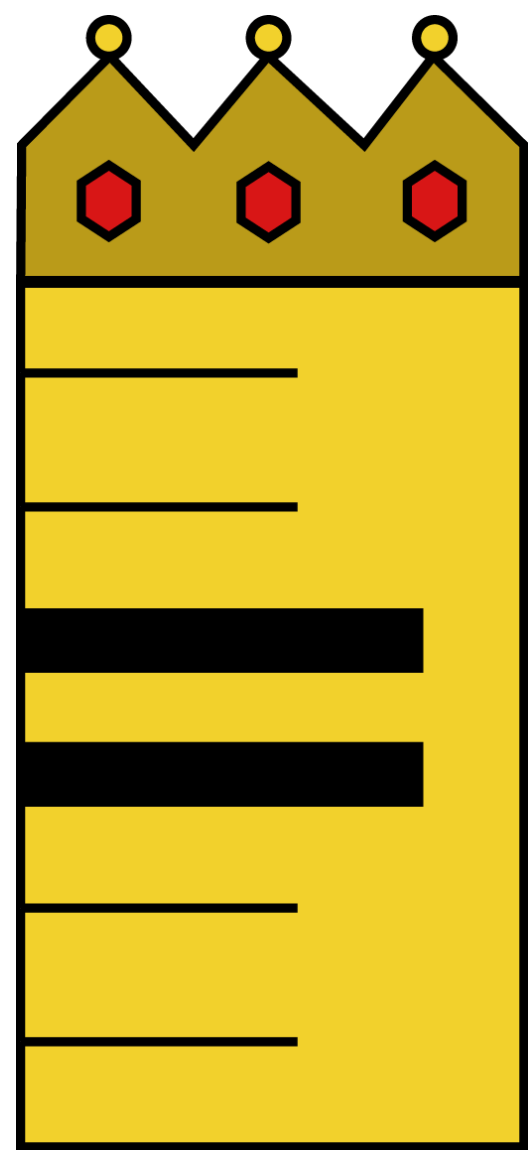

<https://github.com/uwplse/ruler>

Implemented in Rust

Uses *egg* for equality saturation

Evaluation

Ruler vs Other tools (CVC4)

How do the rulesets compare?

Comparison with CVC4

Parameters		Ruler			CVC4			Ruler / CVC4	
Domain	# Conn	Time (s)	# Rules	Drv	Time (s)	# Rules	Drv	Time	Rules
bool	2	0.01	20	1	0.13	53	1	0.06	0.38
bool	3	0.06	28	1	0.82	293	1	0.07	0.10
bv4	2	0.14	49	1	4.47	135	0.98	0.03	0.36
bv4	3	4.30	272	1	372.26	1978	1	0.01	0.14
bv32	2	13.00	46	0.97	18.53	126	0.93	0.70	0.37
bv32	3	630.09	188	0.98	1199.53	1782	0.91	0.53	0.11

Comparison with CVC4

Parameters		Ruler			CVC4			Ruler / CVC4	
Domain	# Conn	Time (s)	# Rules	Drv	Time (s)	# Rules	Drv	Time	Rules
bool	2	0.01	20	1	0.13	53	1	0.06	0.38
bool	3	0.06	28	1	0.82	293	1	0.07	0.10
bv4	2	0.14	49	1	4.47	135	0.98	0.03	0.36
bv4	3	4.30	272	1	372.26	1978	1	0.01	0.14
bv32	2	13.00	46	0.97	18.53	126	0.93	0.70	0.37
bv32	3	630.09	188	0.98	1199.53	1782	0.91	0.53	0.11

Comparison with CVC4

Parameters		Ruler			CVC4			Ruler / CVC4	
Domain	# Conn	Time (s)	# Rules	Drv	Time (s)	# Rules	Drv	Time	Rules
bool	2	0.01	20	1	0.13	53	1	0.06	0.38
bool	3	0.06	28	1	0.82	293	1	0.07	0.10
bv4	2	0.14	49	1	4.47	135	0.98	0.03	0.36
bv4	3	4.30	272	1	372.26	1978	1	0.01	0.14
bv32	2	13.00	46	0.97	18.53	126	0.93	0.70	0.37
bv32	3	630.09	188	0.98	1199.53	1782	0.91	0.53	0.11

Comparison with CVC4

Parameters		Ruler			CVC4			Ruler / CVC4	
Domain	# Conn	Time (s)	# Rules	Drv	Time (s)	# Rules	Drv	Time	Rules
bool	2	0.01	20	1	0.13	53	1	0.06	0.38
bool	3	0.06	28	1	0.82	293	1	0.07	0.10
bv4	2	0.14	49	1	4.47	135	0.98	0.03	0.36
bv4	3	4.30	272	1	372.26	1978	1	0.01	0.14
bv32	2	13.00	46	0.97	18.53	126	0.93	0.70	0.37
bv32	3	630.09	188	0.98	1199.53	1782	0.91	0.53	0.11

Comparison with CVC4

Parameters		Ruler			CVC4			Ruler / CVC4	
Domain	# Conn	Time (s)	# Rules	Drv	Time (s)	# Rules	Drv	Time	Rules
bool	2	0.01	20	1	0.13	53	1	0.06	0.38
bool	3	0.06	28	1	0.82	293	1	0.07	0.10
bv4	2	0.14	49	1	4.47	135	0.98	0.03	0.36
bv4	3	4.30	272	1	372.26	1978	1	0.01	0.14
bv32	2	13.00	46	0.97	18.53	126	0.93	0.70	0.37
bv32	3	630.09	188	0.98	1199.53	1782	0.91	0.53	0.11

Fraction of the 1782 rules from CVC4 that the 188 rules from Ruler can derive via equality saturation

Comparison with CVC4

Parameters		Ruler			CVC4			Ruler / CVC4	
Domain	# Conn	Time (s)	# Rules	Drv	Time (s)	# Rules	Drv	Time	Rules
bool	2	0.01	20	1	0.13	53	1	0.06	0.38
bool	3	0.06	28	1	0.82	293	1	0.07	0.10
bv4	2	0.14	49	1	4.47	135	0.98	0.03	0.36
bv4	3	4.30	272	1	372.26	1978	1	0.01	0.14
bv32	2	13.00	46	0.97	18.53	126	0.93	0.70	0.37
bv32	3	630.09	188	0.98	1199.53	1782	0.91	0.53	0.11

Ruler infers a **smaller,**
useful ruleset **faster**

Evaluation

Ruler vs Other tools (CVC4)

How do the rulesets compare?

Ruler vs Humans (Herbie)

Can Ruler compete with experts?

Comparison with Human-written Rules



$$\text{sqrt}(x+1) - \text{sqrt}(x) \rightarrow 1/(\text{sqrt}(x+1) + \text{sqrt}(x))$$

Herbie detects inaccurate expressions and finds more accurate replacements. The red expression is inaccurate when $x > 1$; Herbie's replacement, in blue, is accurate for all x .

Comparison with Human-written Rules



$$\text{sqrt}(x+1) - \text{sqrt}(x) \rightarrow 1/(\text{sqrt}(x+1) + \text{sqrt}(x))$$

Herbie detects inaccurate expressions and finds more accurate replacements. The red expression is inaccurate when $x > 1$; Herbie's replacement, in blue, is accurate for all x .

52 *rational* rules, designed by the developers over 6 years

55 / 155 benchmarks are purely over rational arithmetic

Comparison with Human-written Rules



$$\text{sqrt}(x+1) - \text{sqrt}(x) \rightarrow 1/(\text{sqrt}(x+1) + \text{sqrt}(x))$$

Herbie detects inaccurate expressions and finds more accurate replacements. The red expression is inaccurate when $x > 1$; Herbie's replacement, in blue, is accurate for all x .

52 *rational* rules, designed by the developers over 6 years

55 / 155 benchmarks are purely over rational arithmetic

Herbie can generate more-complex expressions that aren't more precise #261

Edit

New issue

✓ Closed

nbraud opened this issue on Aug 31, 2019 · 4 comments

Comparison with Human-written Rules



$$\text{sqrt}(x+1) - \text{sqrt}(x) \rightarrow 1/(\text{sqrt}(x+1) + \text{sqrt}(x))$$

Herbie detects inaccurate expressions and finds more accurate replacements. The red expression is inaccurate when $x > 1$; Herbie's replacement, in blue, is accurate for all x .

52 *rational* rules, designed by the developers over 6 years

55 / 155 benchmarks are purely over rational arithmetic

Herbie can generate more-complex expressions that aren't more precise #261

Edit

New issue

Closed nbraud opened this issue on Aug 31, 2019 · 4 comments

$$|x * y| \leftrightarrow |x| * |y|$$

$$|x * x| \leftrightarrow x * x$$

Discovered by Ruler,
resolved the GitHub issue!

End-to-End: Rational Herbie

None: Remove all rules

Herbie: Herbie without any changes

Ruler: Herbie with Ruler's rules

Both: Herbie with both original and Ruler's rules

Rational Herbie: Comparing Accuracy

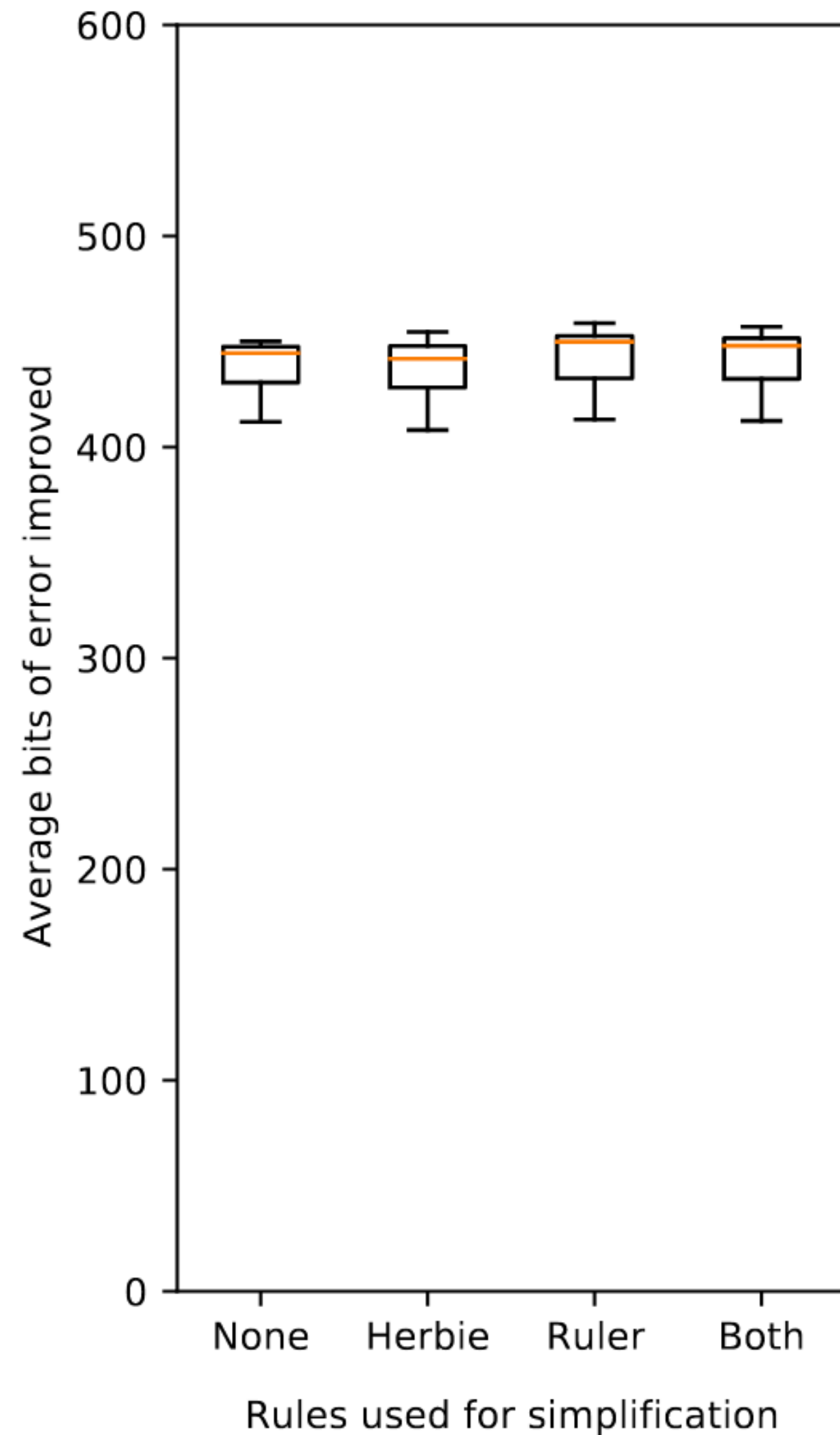

None: Remove all rules

Herbie: Herbie without any changes

Ruler: Herbie with Ruler's rules

Both: Herbie with both original and Ruler's rules

Ruler's rules are at least as good as the original Herbie rules

Rational Herbie: Comparing AST Size

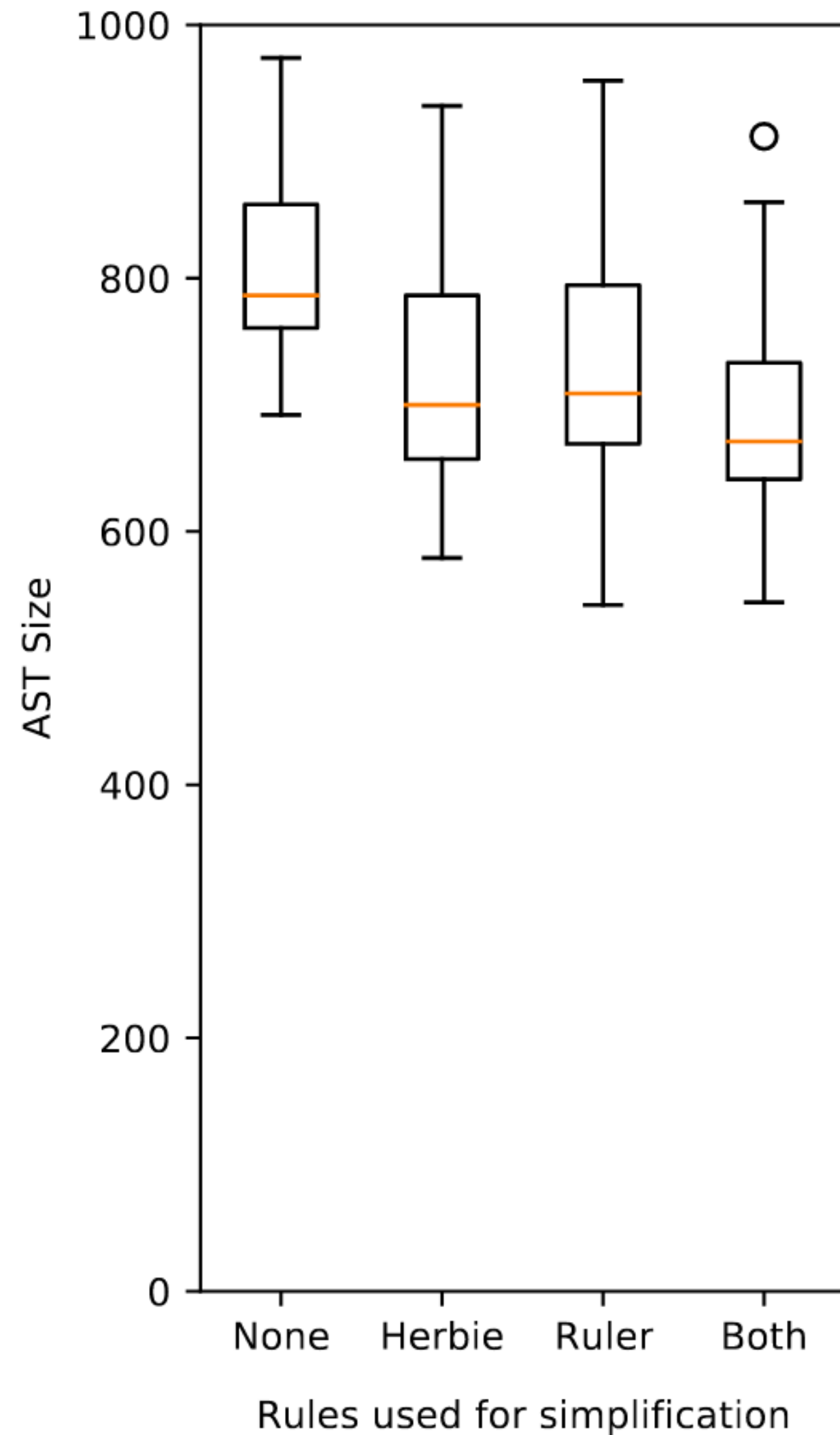

None: Remove all rules

Herbie: Herbie without any changes

Ruler: Herbie with Ruler's rules

Both: Herbie with both original and Ruler's rules

Ruler's rules are at least as good as the original Herbie rules

Rational Herbie: Comparing AST Size

See paper for more results!

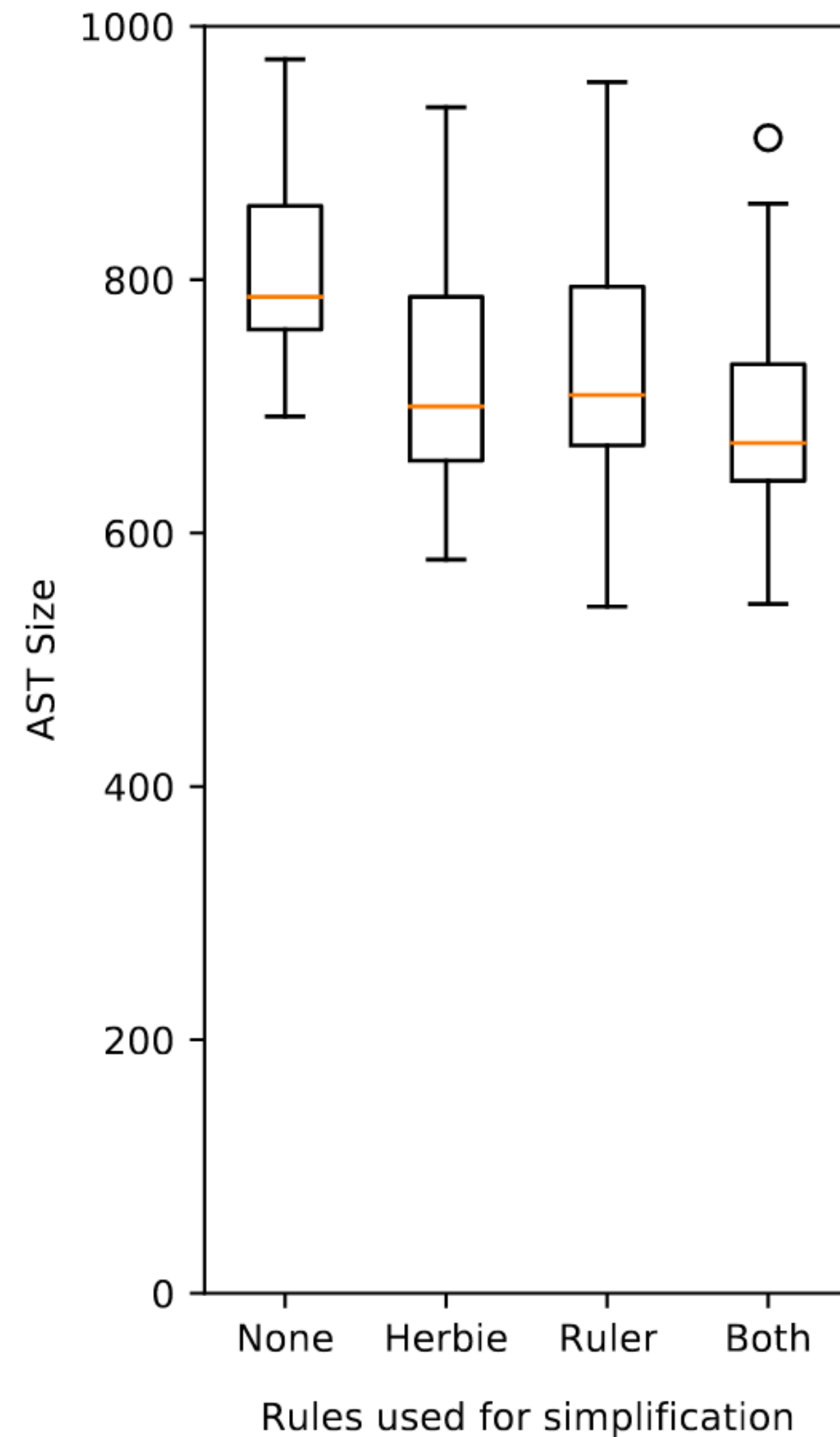

None: Remove all rules

Herbie: Herbie without any changes

Ruler: Herbie with Ruler's rules

Both: Herbie with both original and Ruler's rules

Ruler's rules are at least as good as the original Herbie rules

Rewrite Rule Inference Using Equality Saturation

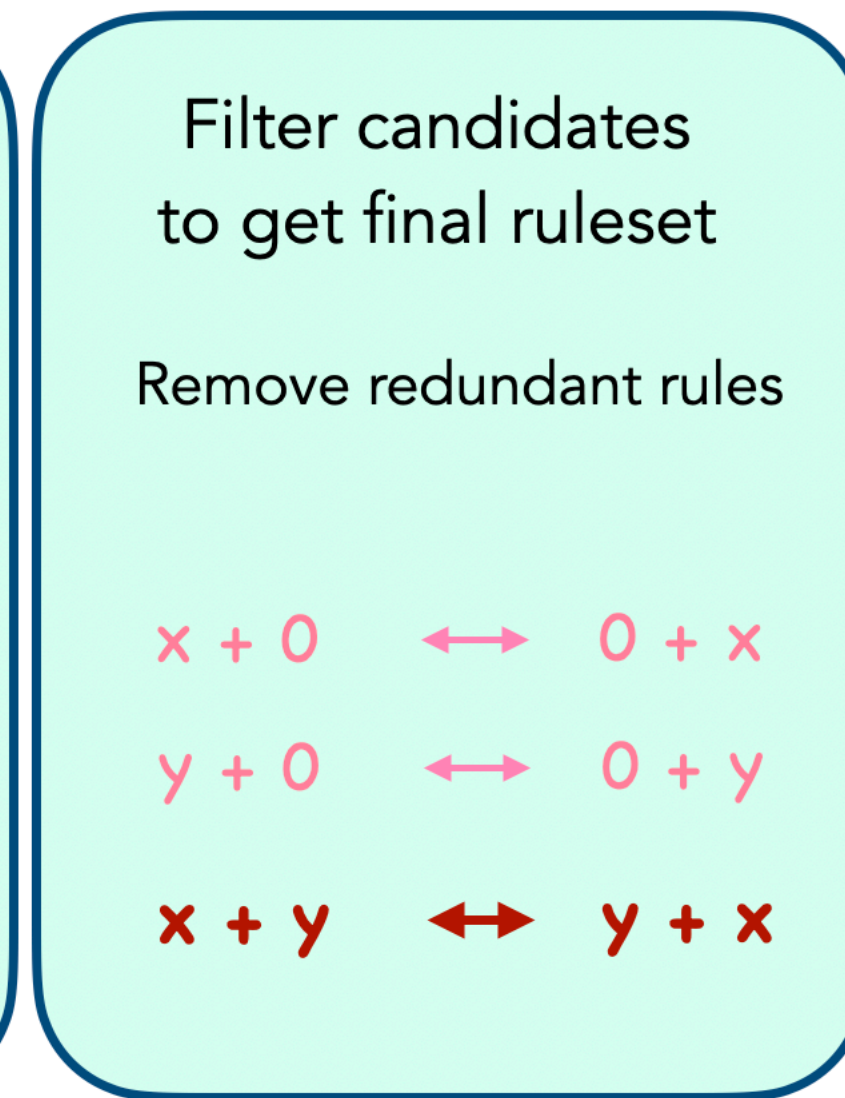
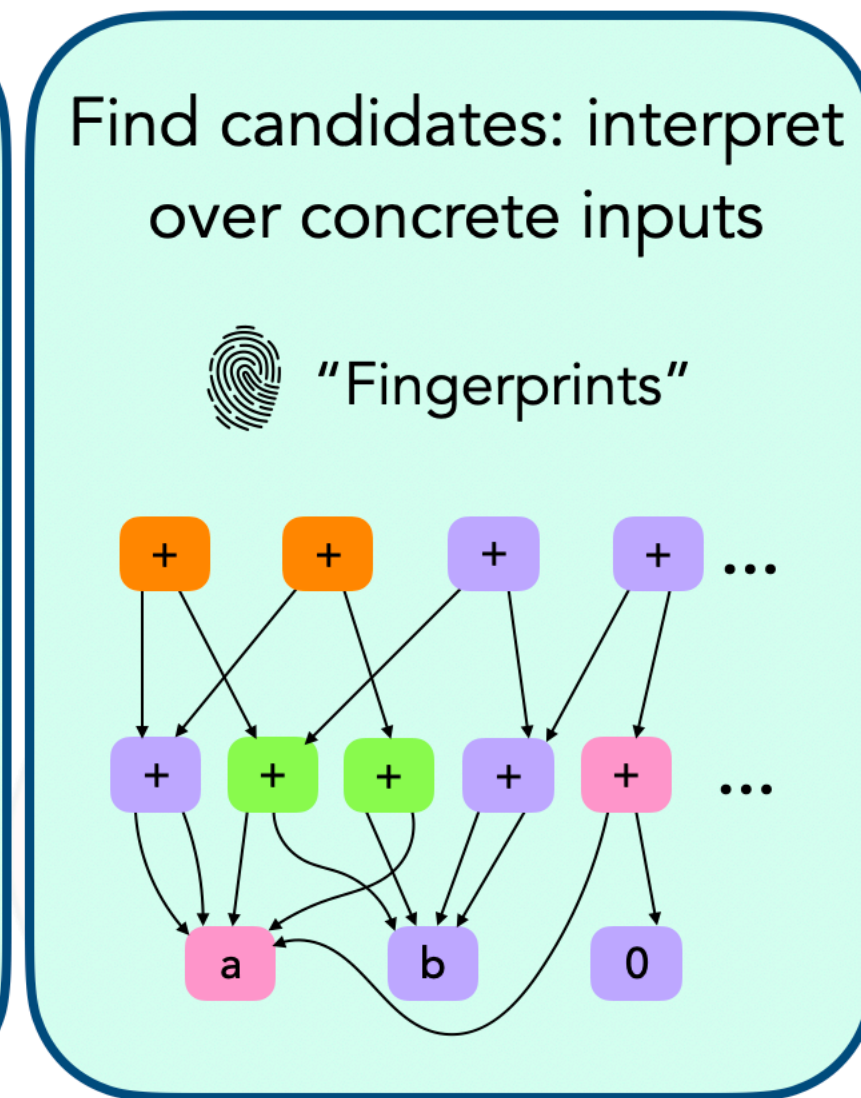
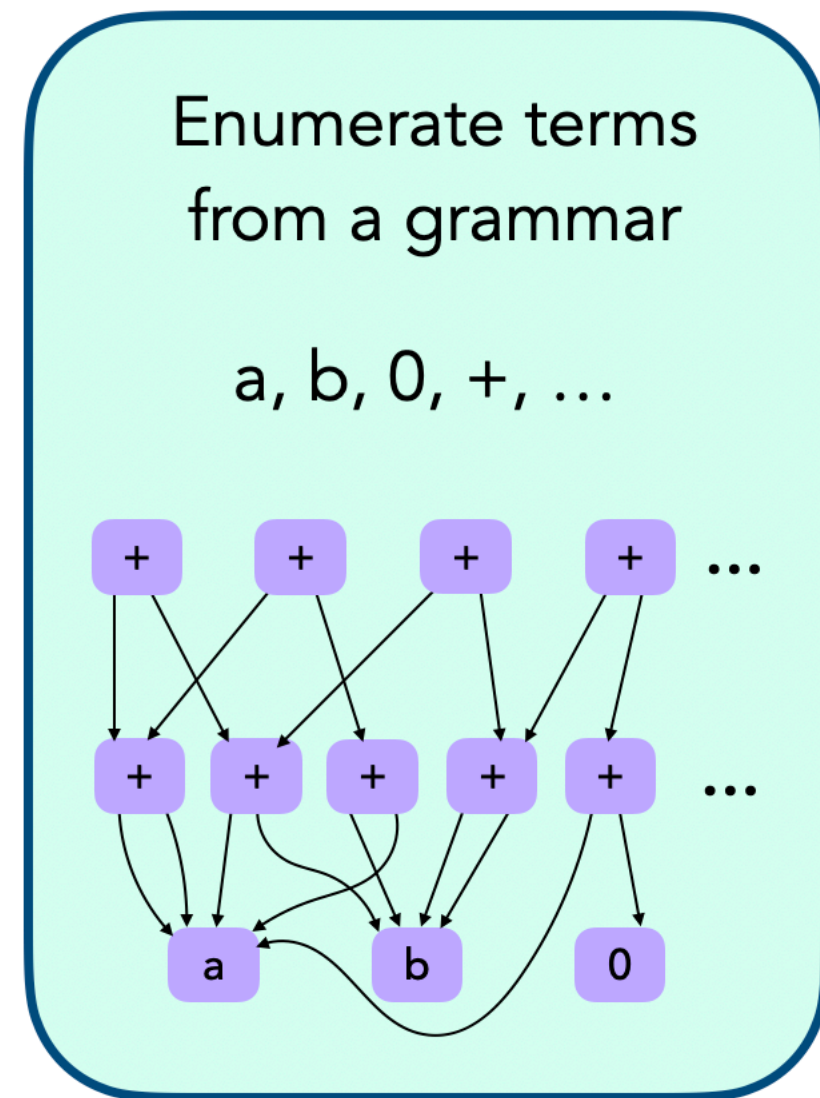

Equality Saturation improves all three steps!

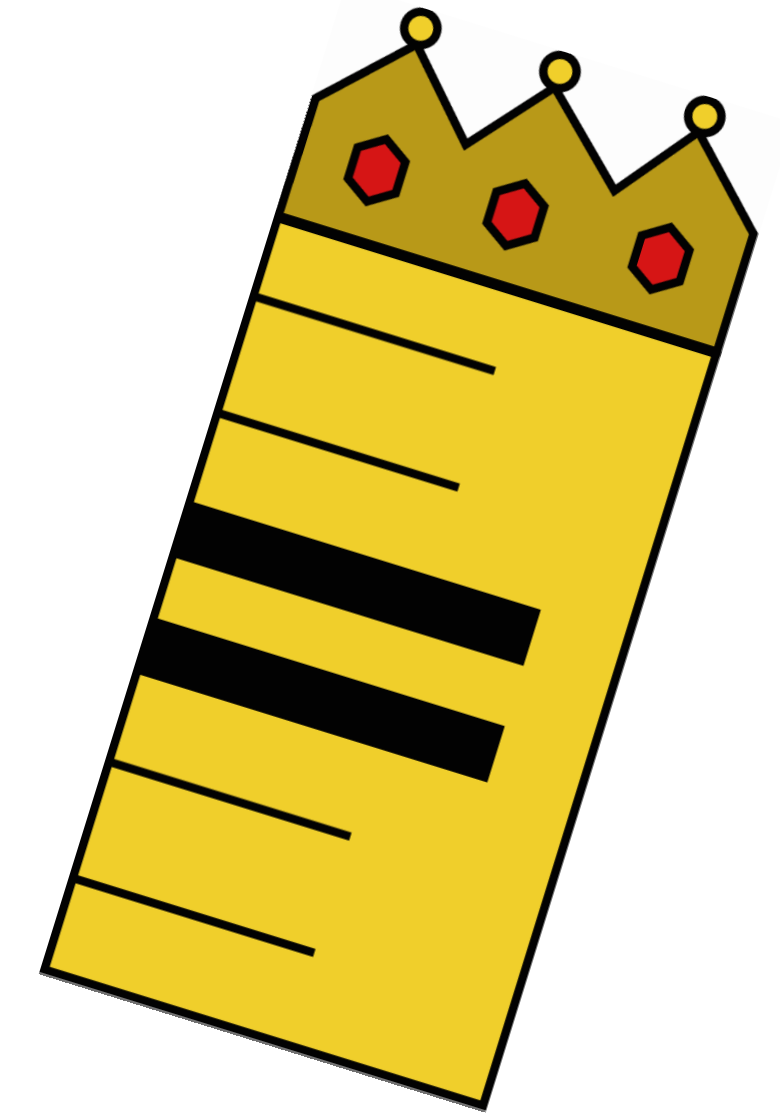

Ruler: <https://github.com/uwplse/ruler>

