

Soviet Rail Network, 1955

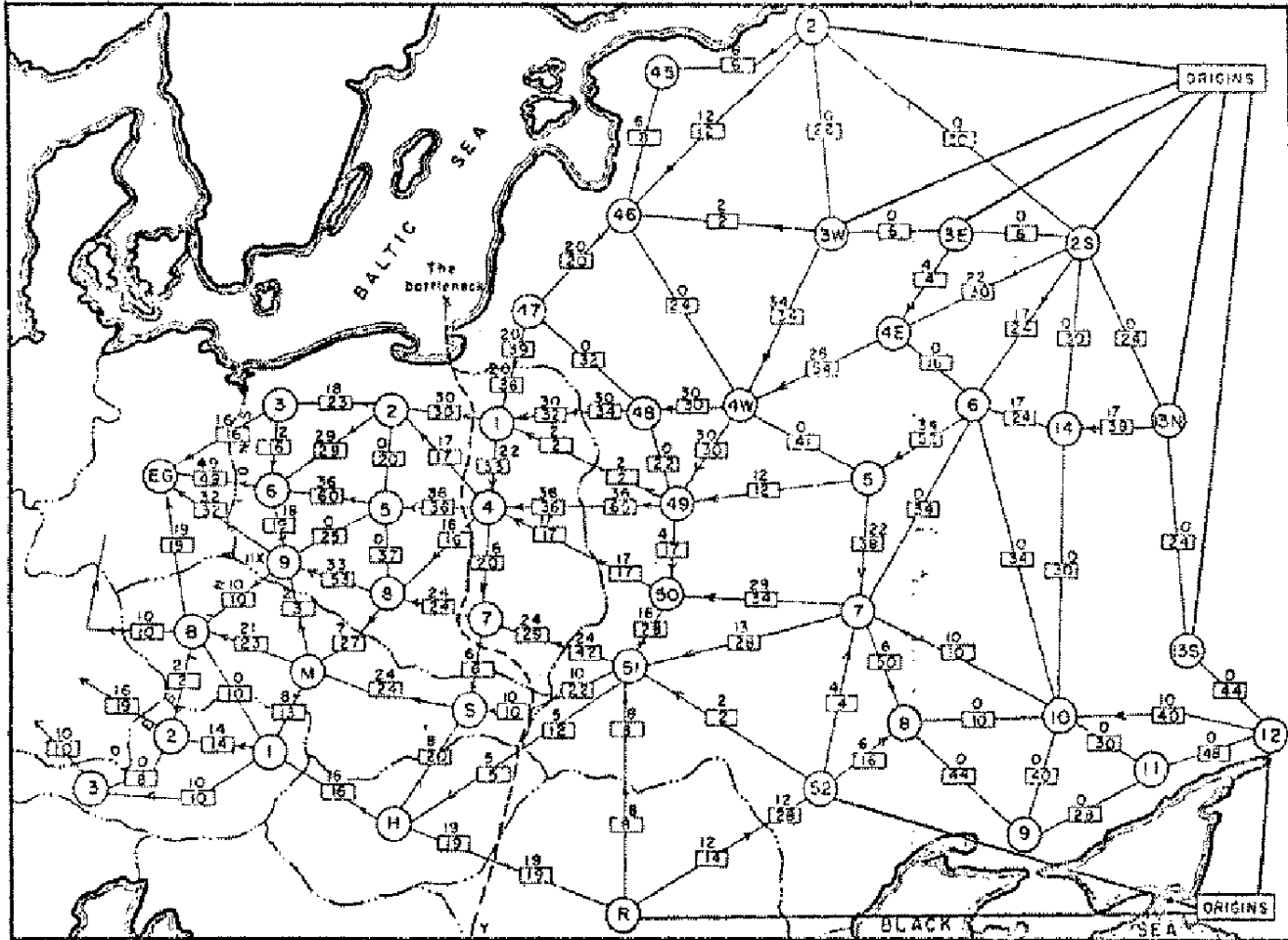

Reference: *On the history of the transportation and maximum flow problems.*
Alexander Schrijver in *Math Programming*, 91: 3, 2002.

Maximum Flow and Minimum Cut

Max flow and min cut.

- Two very rich algorithmic problems.
- Cornerstone problems in combinatorial optimization.
- Beautiful mathematical duality.

Nontrivial applications / reductions.

- Data mining.
- Open-pit mining.
- Project selection.
- Airline scheduling.
- Bipartite matching.
- Baseball elimination.
- Image segmentation.
- Network connectivity.
- Network reliability.
- Distributed computing.
- Egalitarian stable matching.
- Security of statistical data.
- Network intrusion detection.
- Multi-camera scene reconstruction.
- Many many more . . .

Minimum Cut Problem

Flow network.

- Abstraction for material **flowing** through the edges.
- $G = (V, E)$ = directed graph, no parallel edges.
- Two distinguished nodes: s = source, t = sink.
- $c(e)$ = capacity of edge e , a non-negative integer.

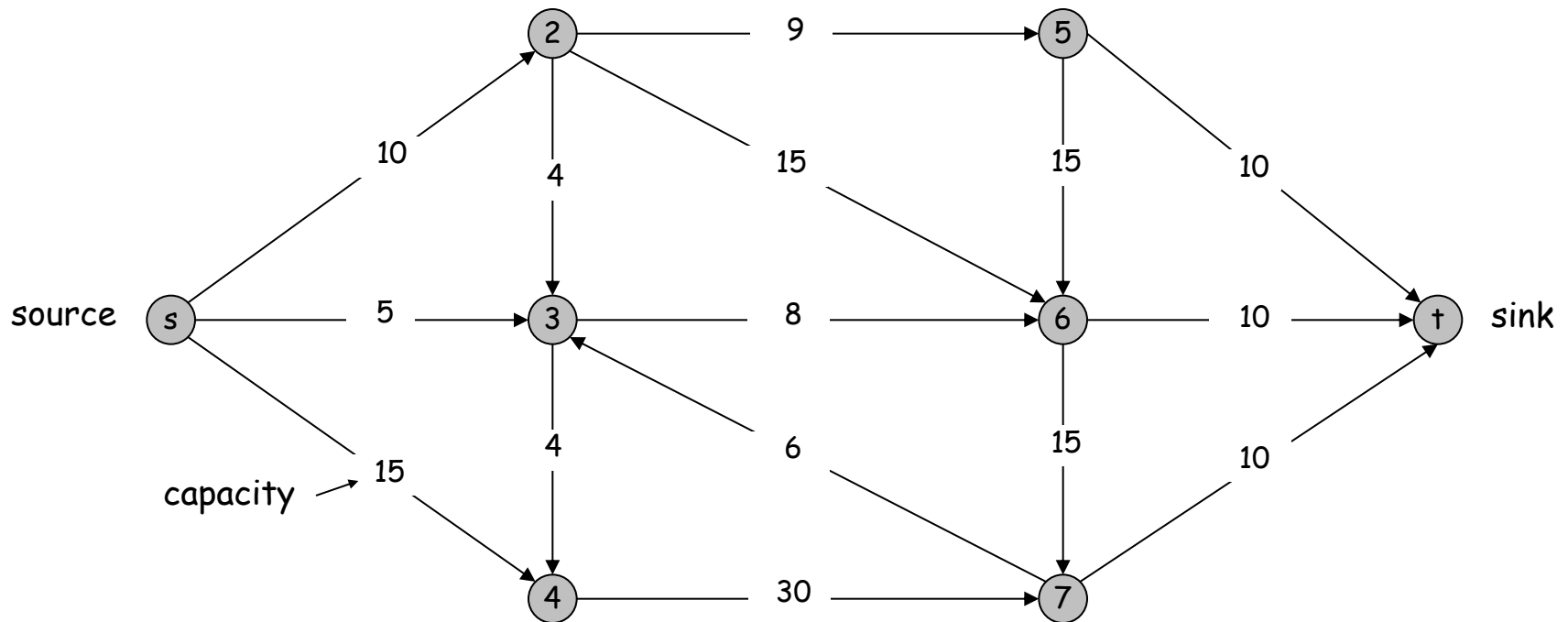

Cuts

Def. An **s-t cut** is a partition (A, B) of V with $s \in A$ and $t \in B$.

Def. The **capacity** of a cut (A, B) is: $cap(A, B) = \sum_{e \text{ out of } A} c(e)$

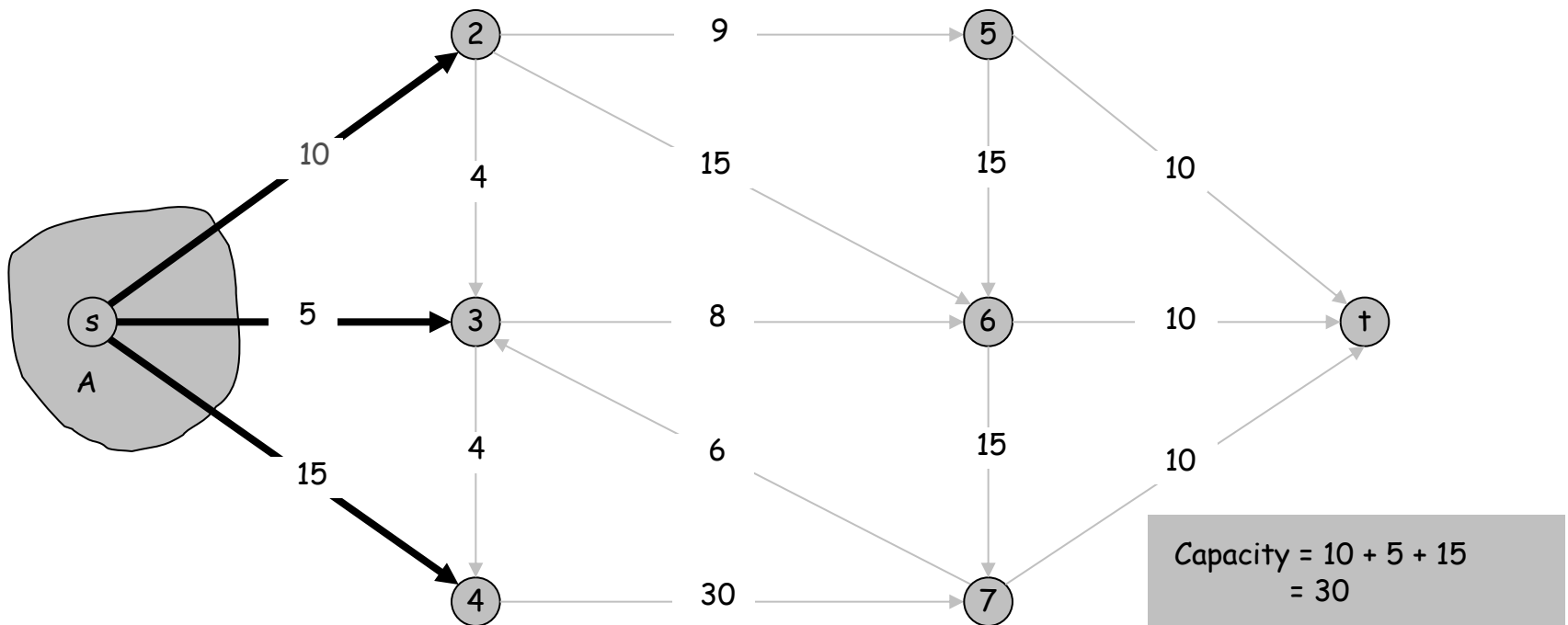

Cuts

Def. An **s-t cut** is a partition (A, B) of V with $s \in A$ and $t \in B$.

Def. The **capacity** of a cut (A, B) is: $cap(A, B) = \sum_{e \text{ out of } A} c(e)$

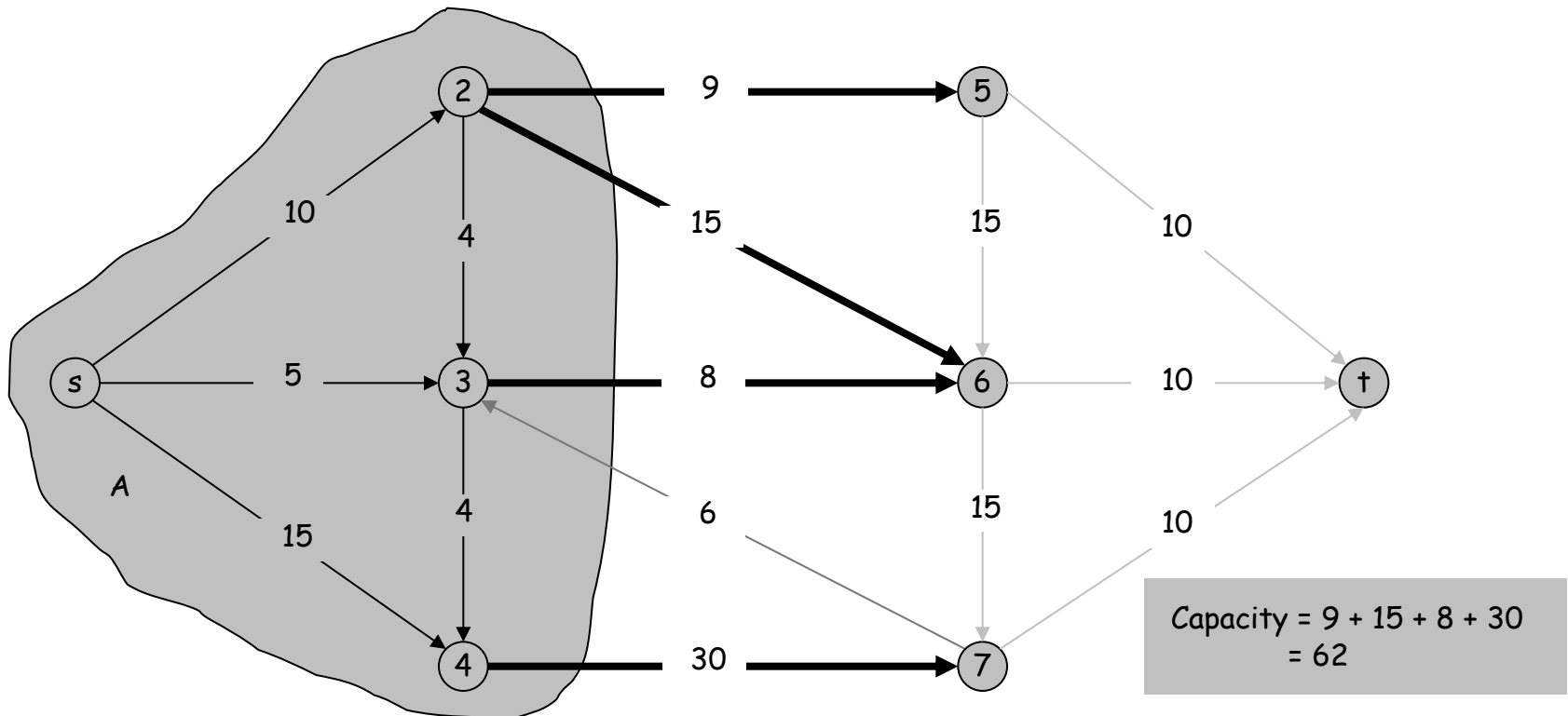

Minimum Cut Problem

Min s-t cut problem. Find an s-t cut of minimum capacity.

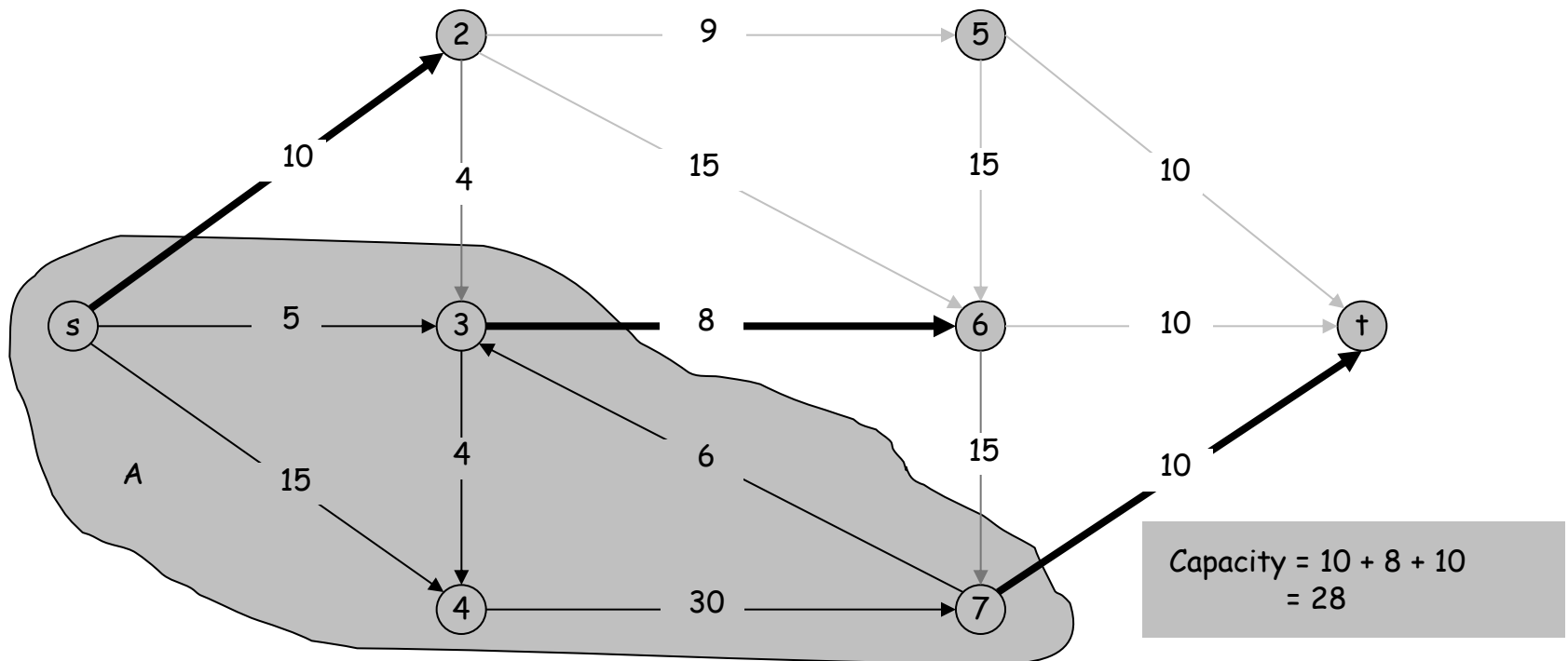

Flows

Def. An **s-t flow** is a function that satisfies:

- For each $e \in E$: $0 \leq f(e) \leq c(e)$ (capacity)
- For each $v \in V - \{s, t\}$: $\sum_{e \text{ in to } v} f(e) = \sum_{e \text{ out of } v} f(e)$ (conservation)

Def. The **value** of a flow f is: $v(f) = \sum_{e \text{ out of } s} f(e)$.

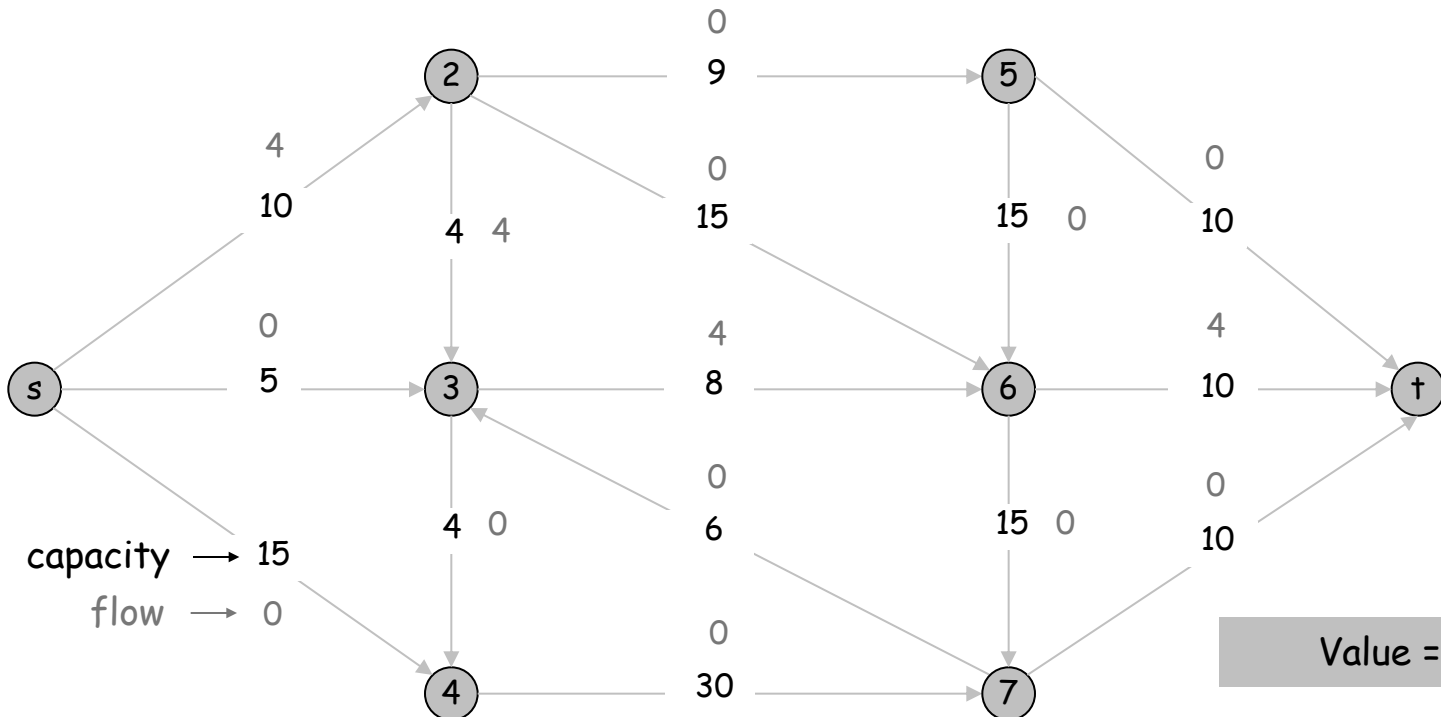

Def. An **s-t flow** is a function that satisfies:

- For each $e \in E$: $0 \leq f(e) \leq c(e)$ (capacity)
- For each $v \in V - \{s, t\}$: $\sum_{e \text{ in to } v} f(e) = \sum_{e \text{ out of } v} f(e)$ (conservation)

Def. The **value** of a flow f is: $v(f) = \sum_{e \text{ out of } s} f(e)$.

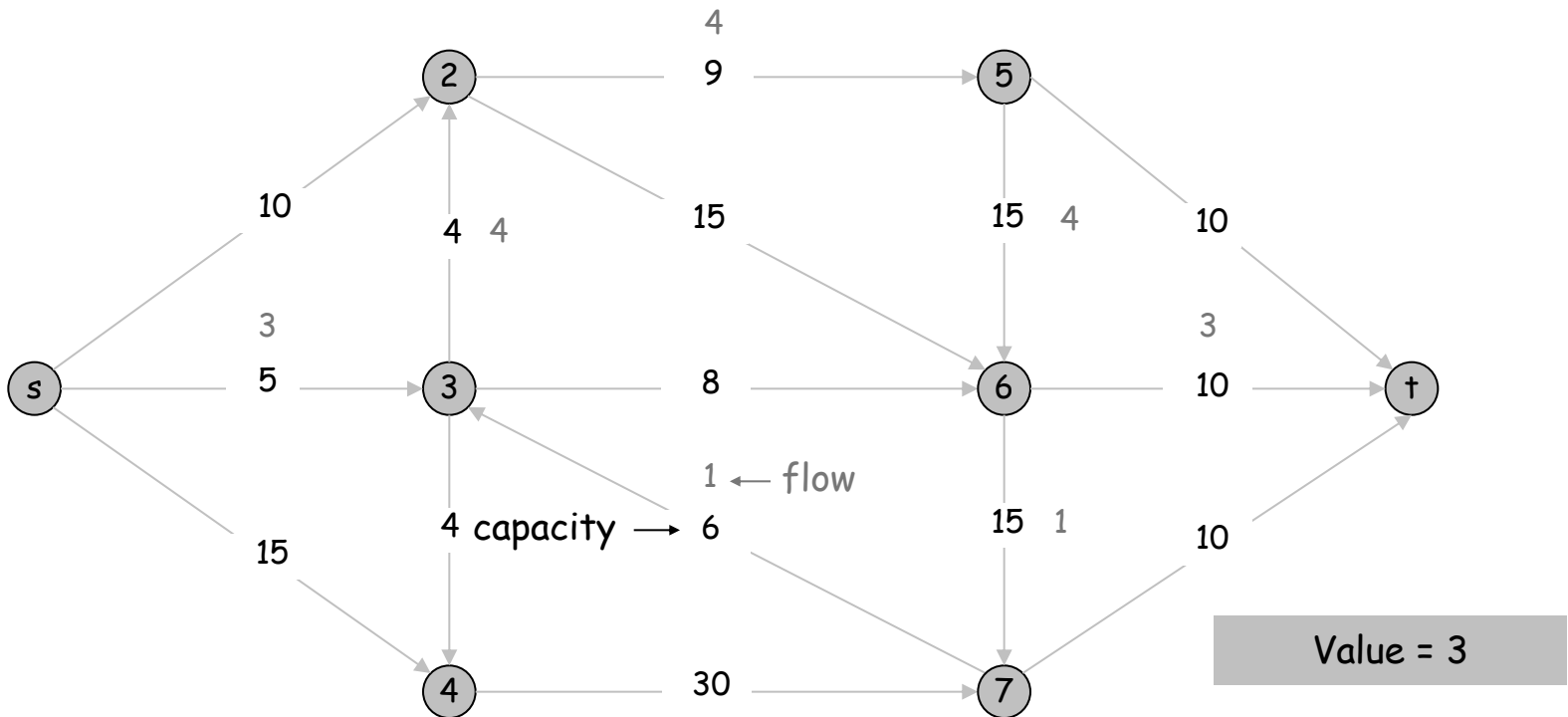

Flows

Def. An **s-t flow** is a function that satisfies:

- For each $e \in E$: $0 \leq f(e) \leq c(e)$ (capacity)
- For each $v \in V - \{s, t\}$: $\sum_{e \text{ in to } v} f(e) = \sum_{e \text{ out of } v} f(e)$ (conservation)

Def. The **value** of a flow f is: $v(f) = \sum_{e \text{ out of } s} f(e)$.

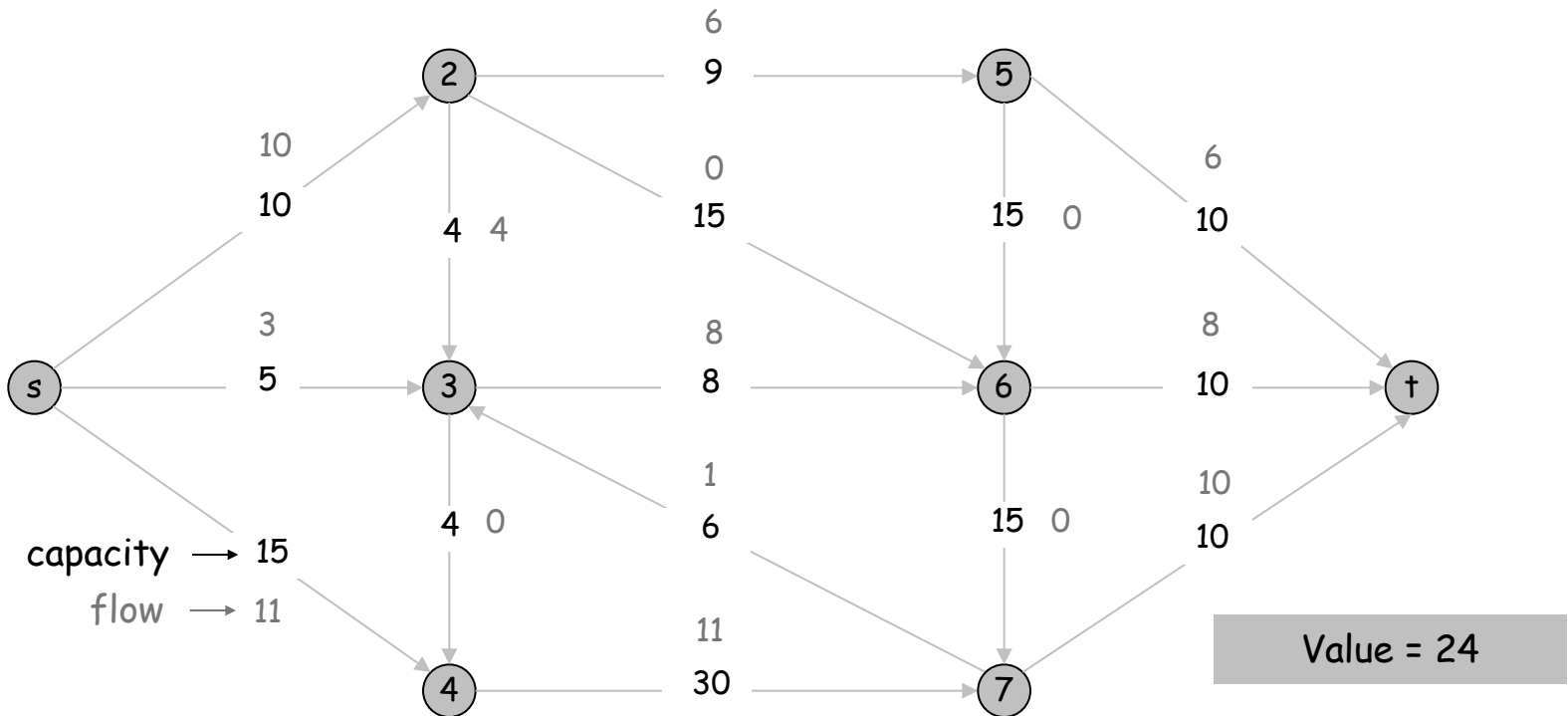

Maximum Flow Problem

Max flow problem. Find s-t flow of maximum value.

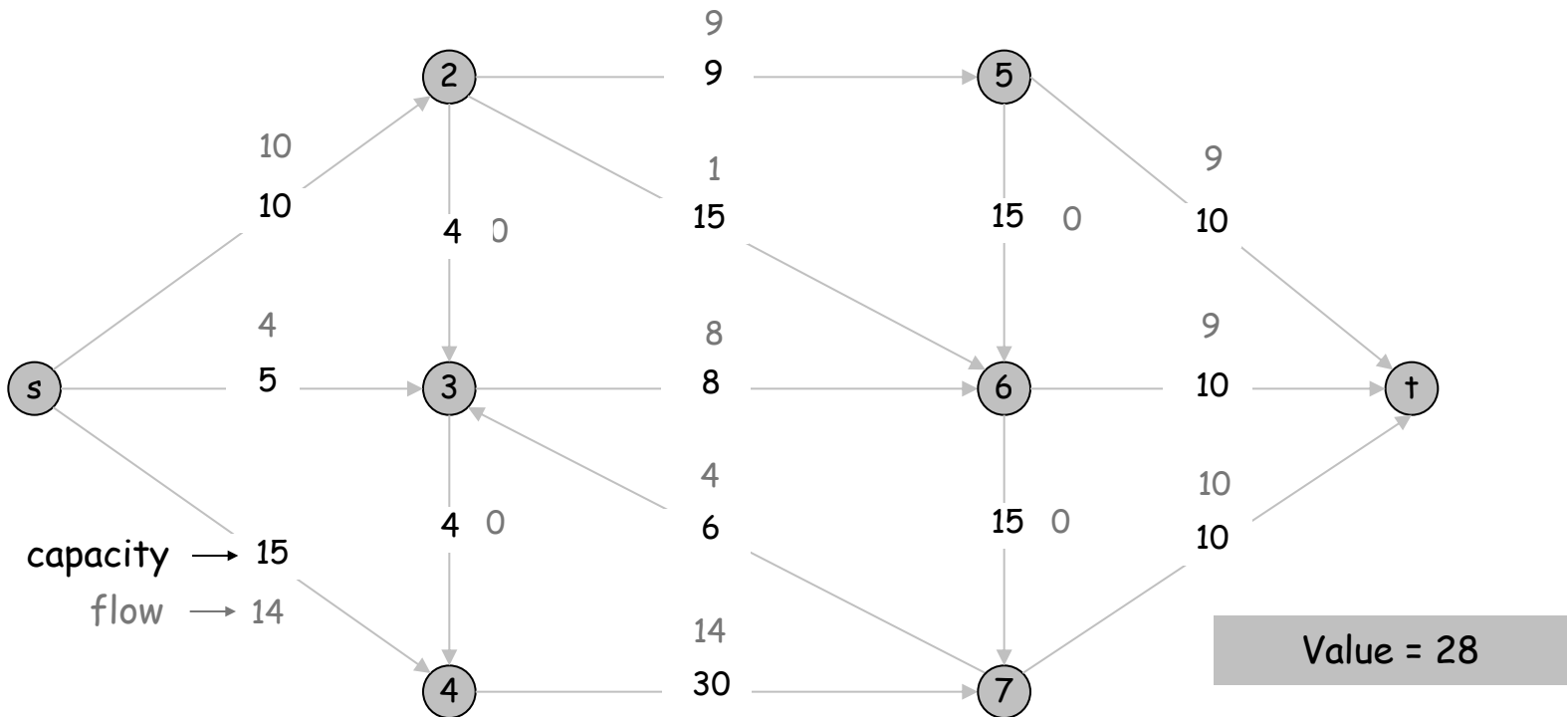

Flows and Cuts

Flow value lemma. Let f be any flow, and let (A, B) be any s - t cut. Then, the net flow sent across the cut is equal to the amount leaving s .

$$\sum_{e \text{ out of } A} f(e) - \sum_{e \text{ in to } A} f(e) = v(f)$$

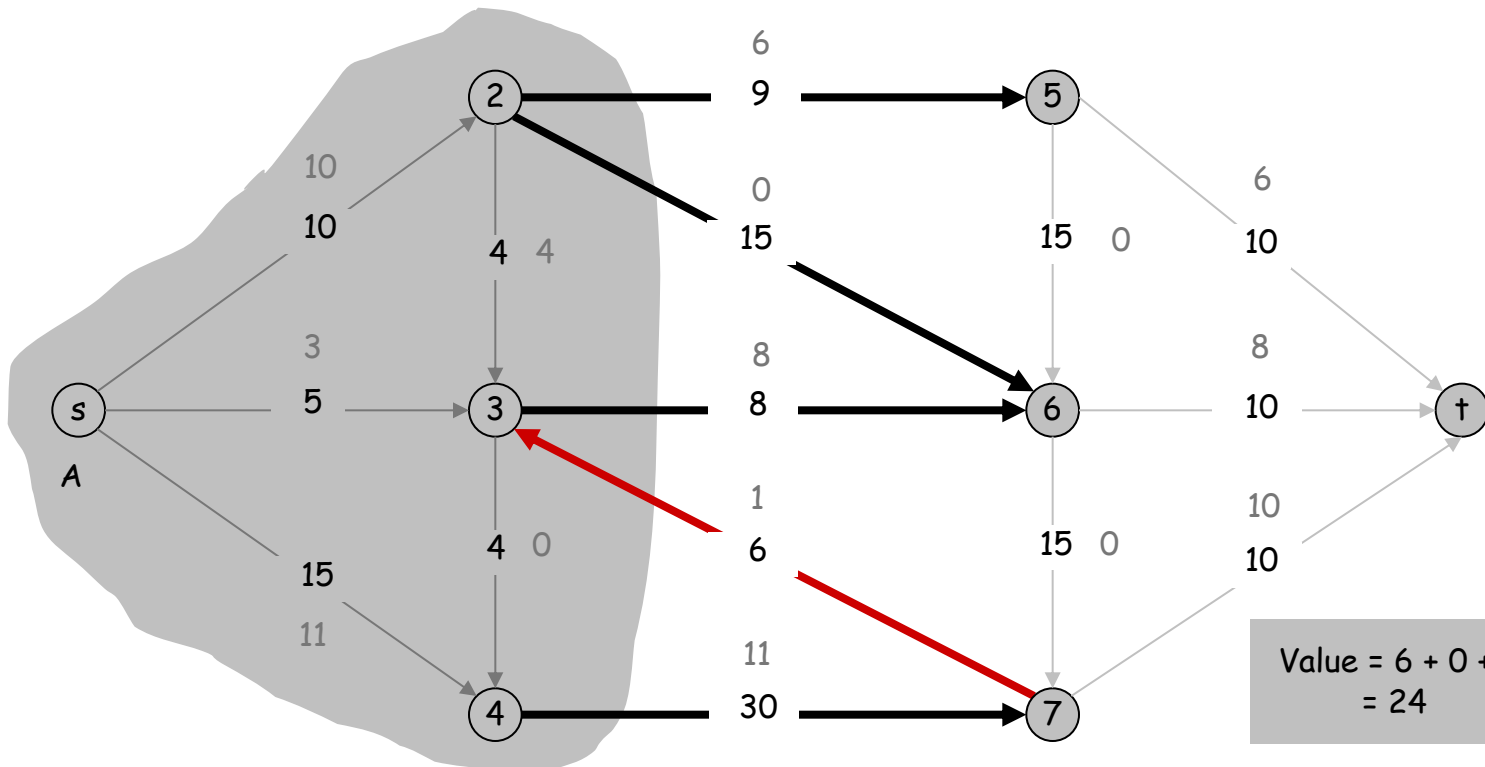

Flows and Cuts

Flow value lemma. Let f be any flow, and let (A, B) be any s - t cut. Then, the net flow sent across the cut is equal to the amount leaving s .

$$\sum_{e \text{ out of } A} f(e) - \sum_{e \text{ in to } A} f(e) = v(f)$$

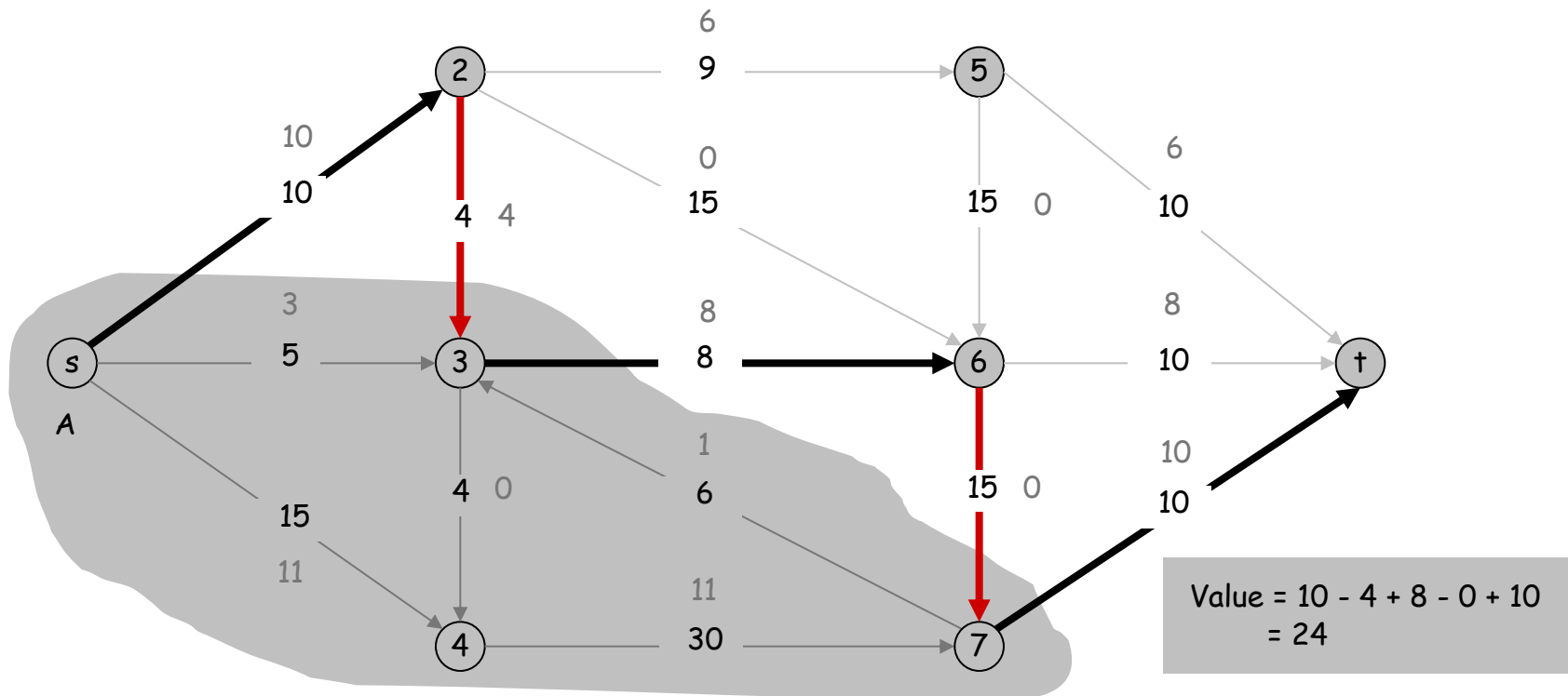

Flows and Cuts

Flow value lemma. Let f be any flow, and let (A, B) be any s - t cut. Then

$$\sum_{e \text{ out of } A} f(e) - \sum_{e \text{ in to } A} f(e) = v(f).$$

Pf.

$$v(f) = \sum_{e \text{ out of } s} f(e)$$

by flow conservation, all terms
except $v = s$ are 0

$$\longrightarrow = \sum_{v \in A} \left(\sum_{e \text{ out of } v} f(e) - \sum_{e \text{ in to } v} f(e) \right)$$

all contributions due to
internal edges cancel

$$\longrightarrow = \sum_{e \text{ out of } A} f(e) - \sum_{e \text{ in to } A} f(e).$$

Flows and Cuts

Weak duality. Let f be any flow, and let (A, B) be any s - t cut. Then the value of the flow is at most the capacity of the cut.

Cut capacity = 30 \Rightarrow Flow value \leq 30

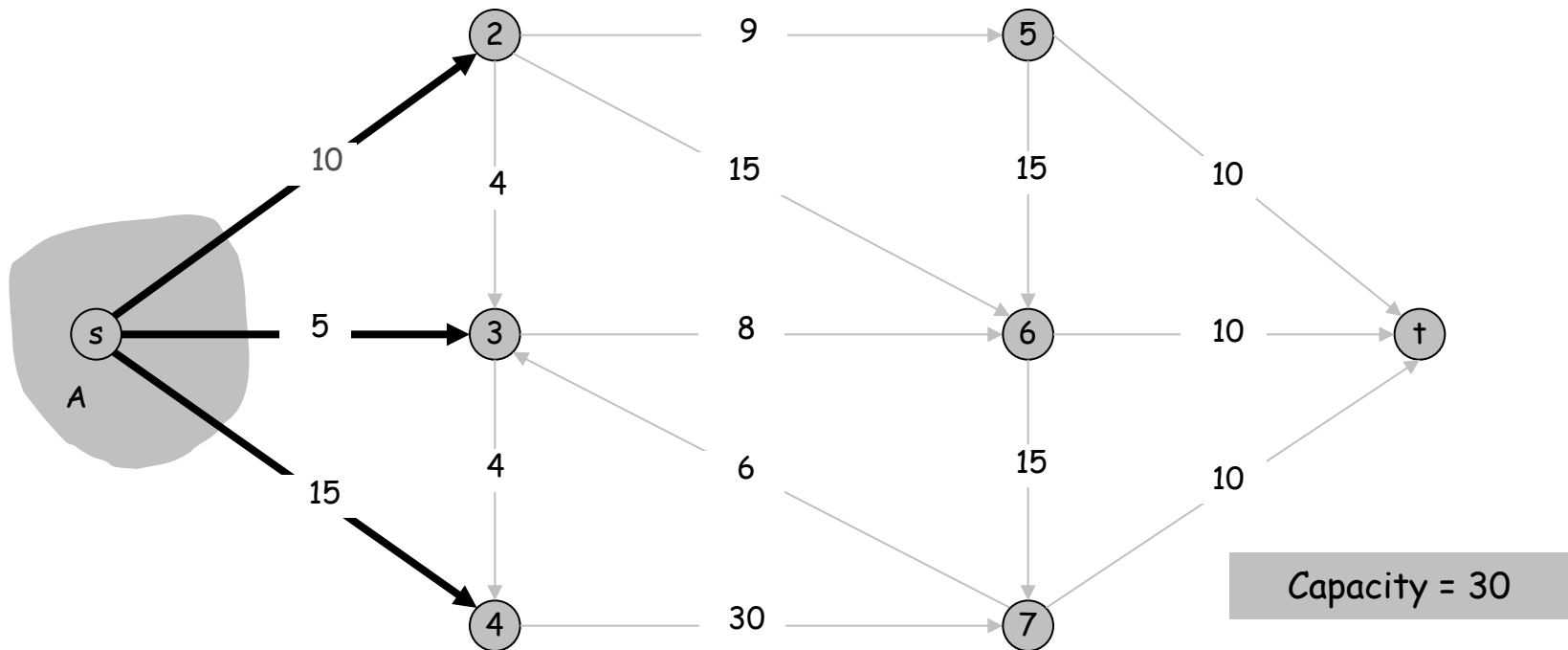

Flows and Cuts

Weak duality. Let f be any flow. Then, for any s - t cut (A, B) we have $v(f) \leq \text{cap}(A, B)$.

Pf.

$$\begin{aligned} v(f) &= \sum_{e \text{ out of } A} f(e) - \sum_{e \text{ in to } A} f(e) \\ &\leq \sum_{e \text{ out of } A} c(e) \\ &\leq \sum_{e \text{ out of } A} c(e) \\ &= \text{cap}(A, B) \quad . \end{aligned}$$

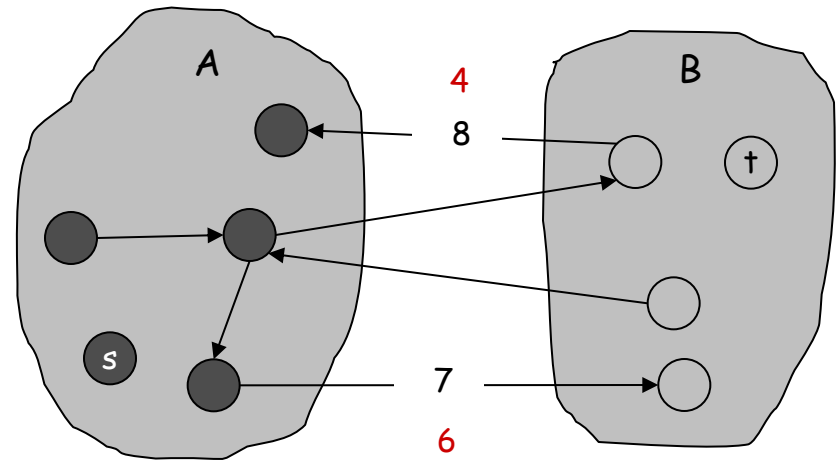

Certificate of Optimality

Corollary. Let f be any flow, and let (A, B) be any cut. If $v(f) = \text{cap}(A, B)$, then f is a max flow and (A, B) is a min cut.

Value of flow = 28
 Cut capacity = 28 \Rightarrow Flow value \leq 28

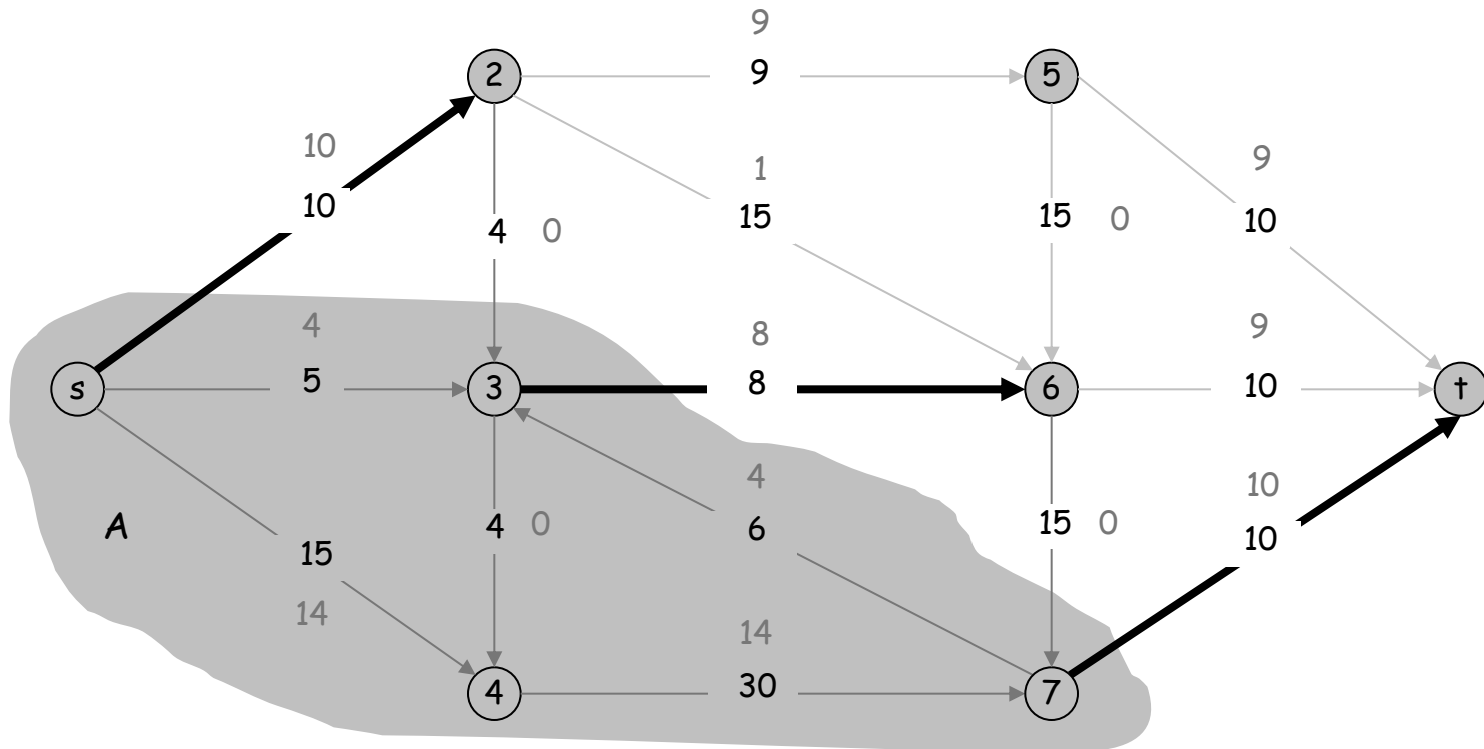

Towards a Max Flow Algorithm

Greedy algorithm.

- Start with $f(e) = 0$ for all edge $e \in E$.
- Find an s - t path P where each edge has $f(e) < c(e)$.
- Augment flow along path P .
- Repeat until you get stuck.

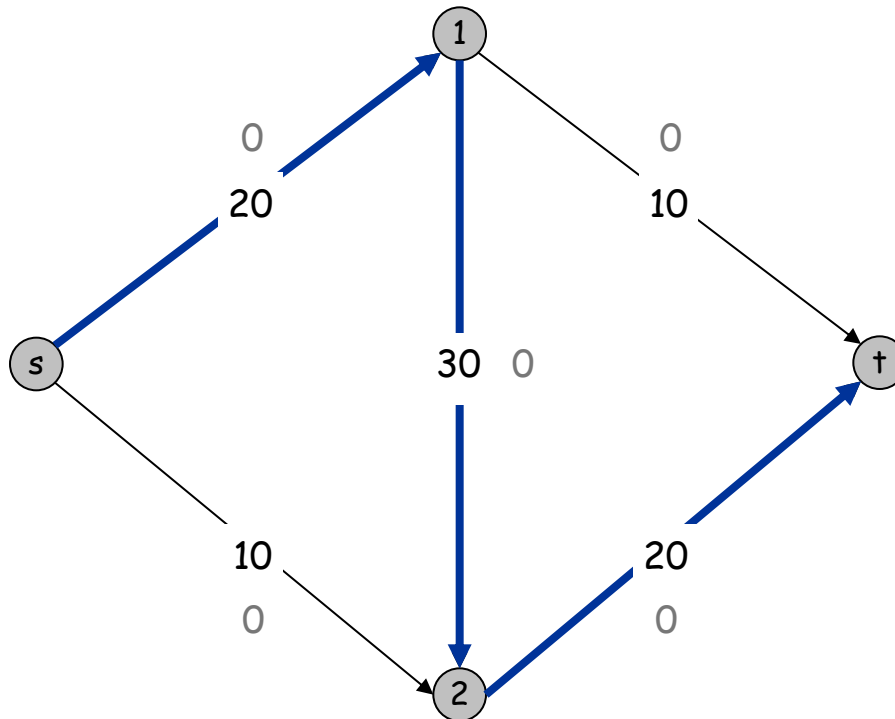

Flow value = 0

Towards a Max Flow Algorithm

Greedy algorithm.

- Start with $f(e) = 0$ for all edge $e \in E$.
- Find an s - t path P where each edge has $f(e) < c(e)$.
- Augment flow along path P .
- Repeat until you get stuck.

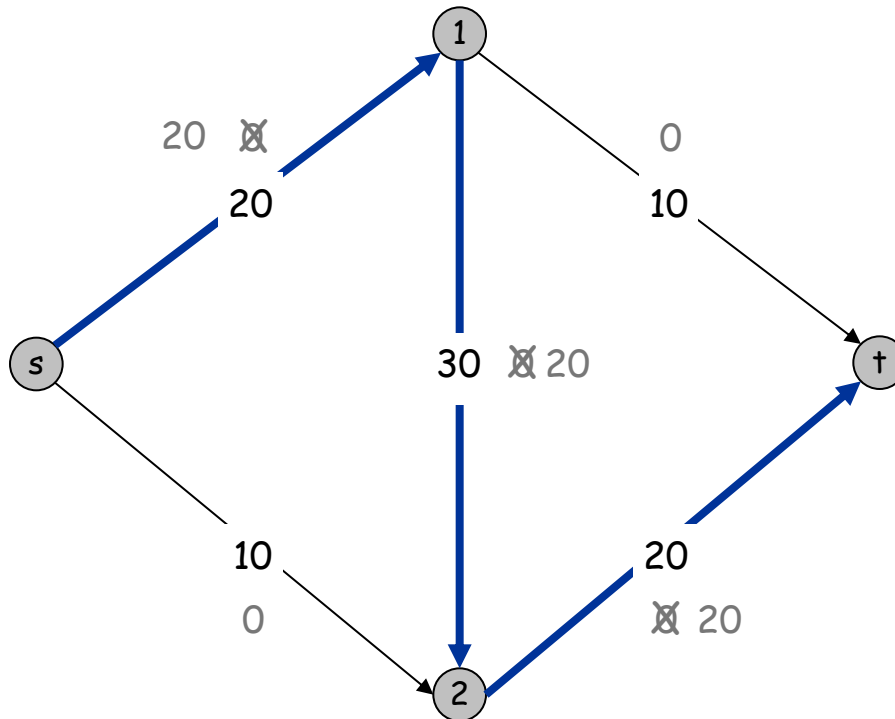

Flow value = 20

Towards a Max Flow Algorithm

Greedy algorithm.

- Start with $f(e) = 0$ for all edge $e \in E$.
- Find an s - t path P where each edge has $f(e) < c(e)$.
- Augment flow along path P .
- Repeat until you get **stuck**.

← locally optimality \neq global optimality

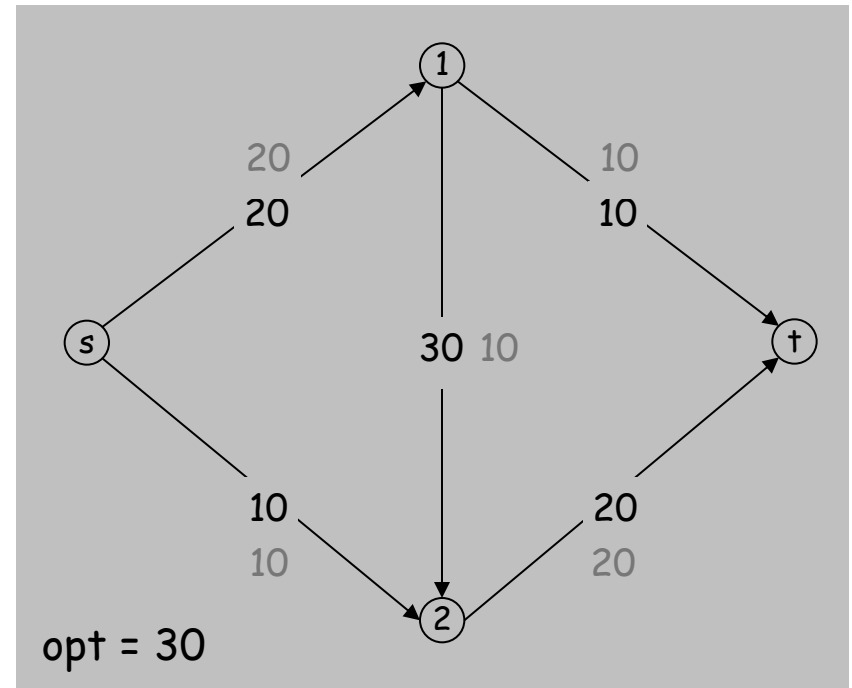
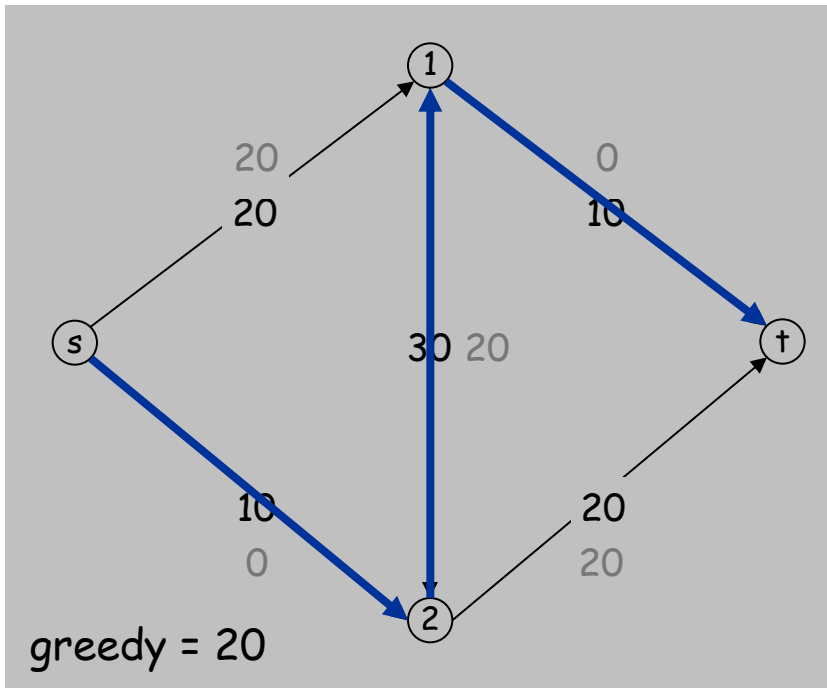

Residual Graph

Original edge: $e = (u, v) \in E$.

- Flow $f(e)$, capacity $c(e)$.

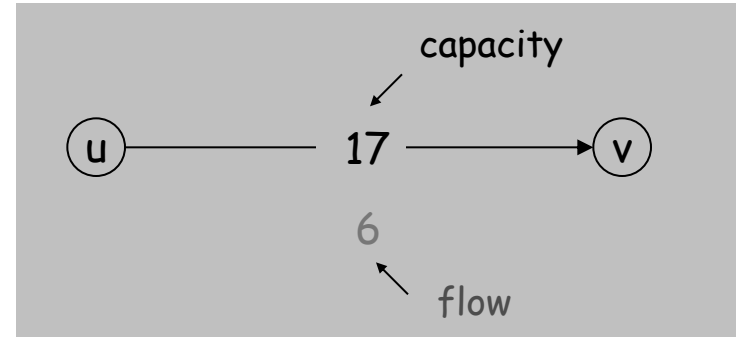

Residual edge.

- "Undo" flow sent.
- $e = (u, v)$ and $e^R = (v, u)$.
- Residual capacity:

$$c_f(e) = \begin{cases} c(e) - f(e) & \text{if } e \in E \\ f(e) & \text{if } e^R \in E \end{cases}$$

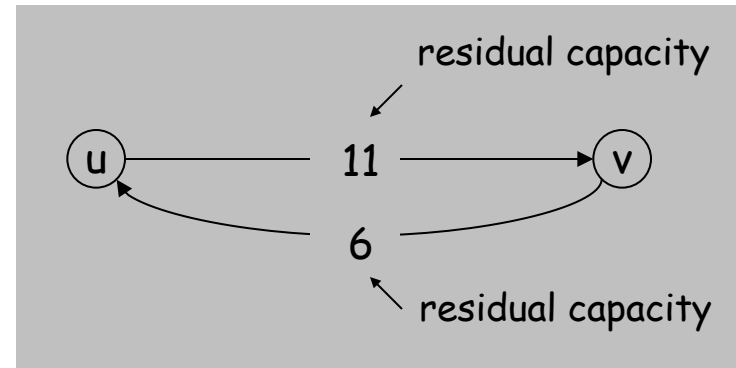

Residual graph: $G_f = (V, E_f)$.

- Residual edges with positive residual capacity.
- $E_f = \{e : f(e) < c(e)\} \cup \{e : f(e) > 0\}$.

Ford-Fulkerson Algorithm

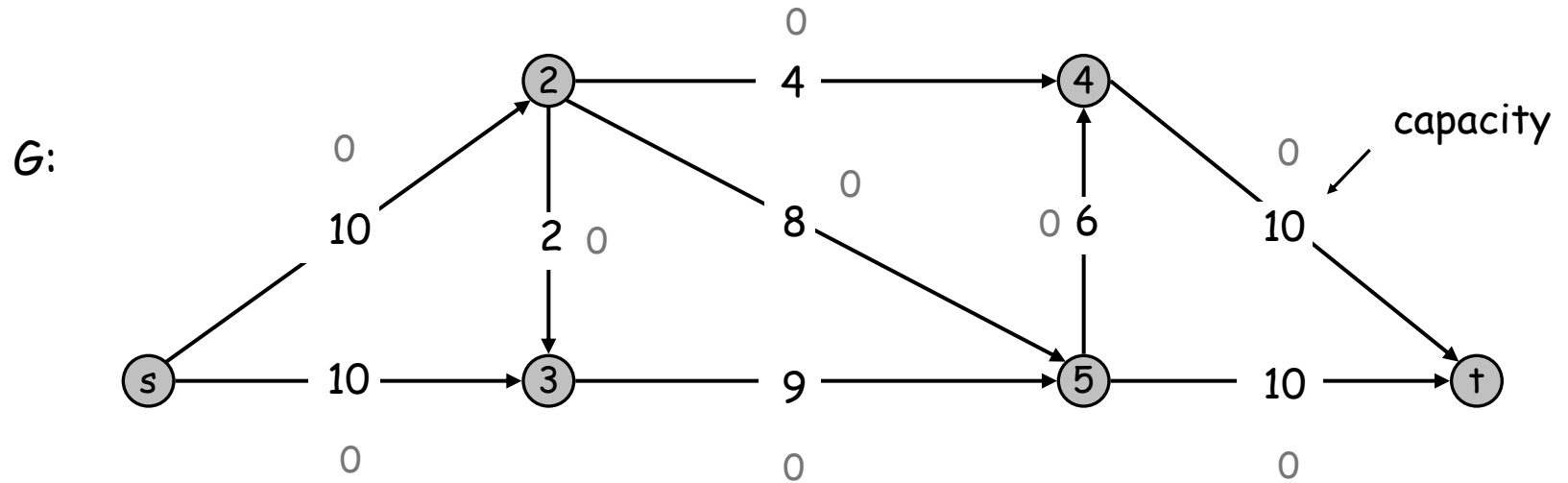

Ford-Fulkerson Algorithm

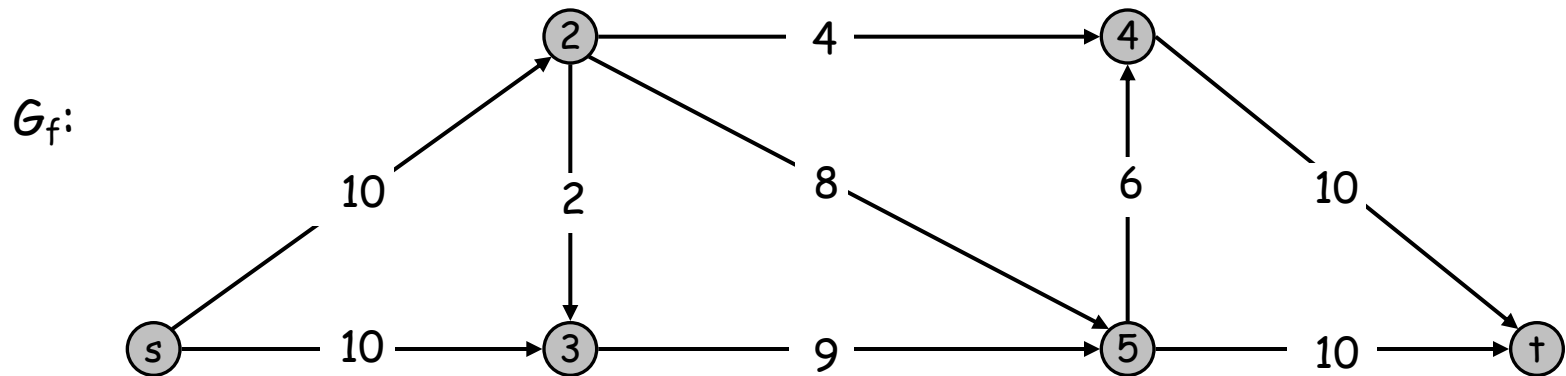
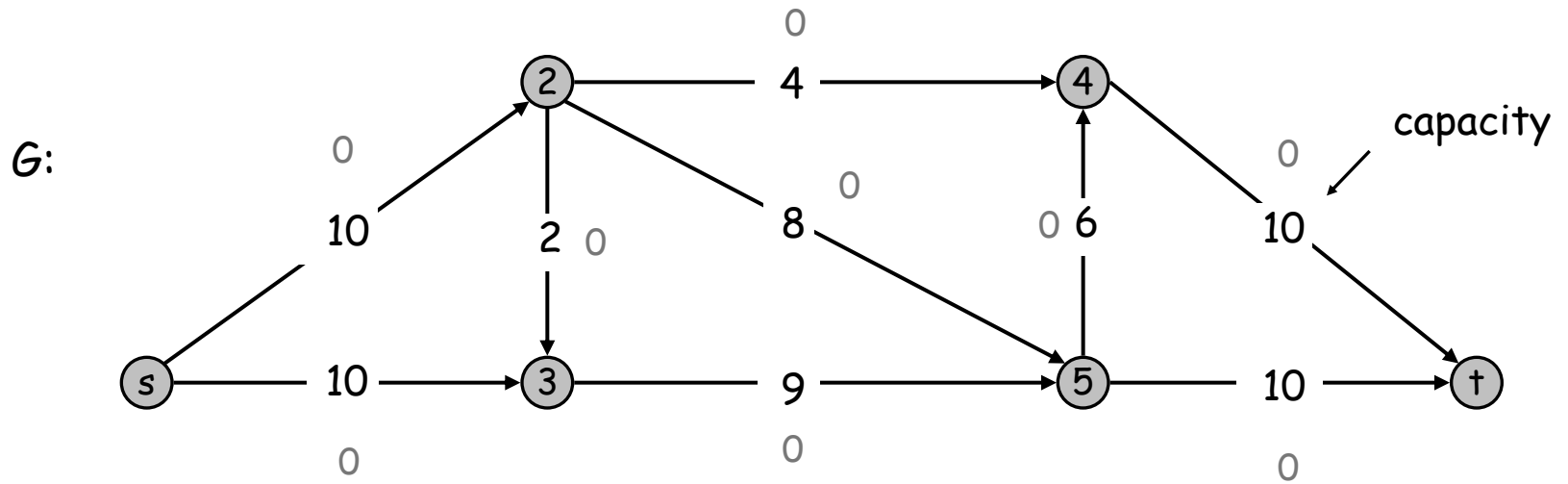

Ford-Fulkerson Algorithm

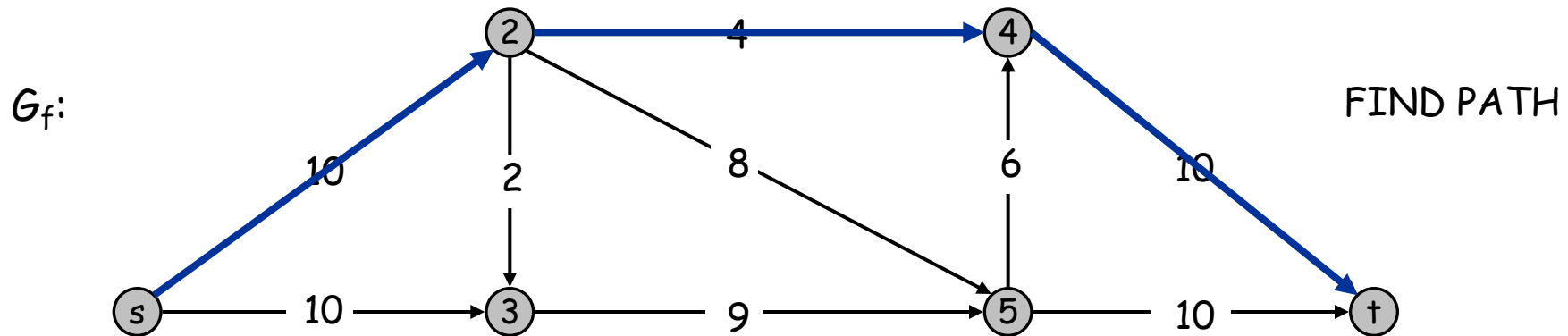
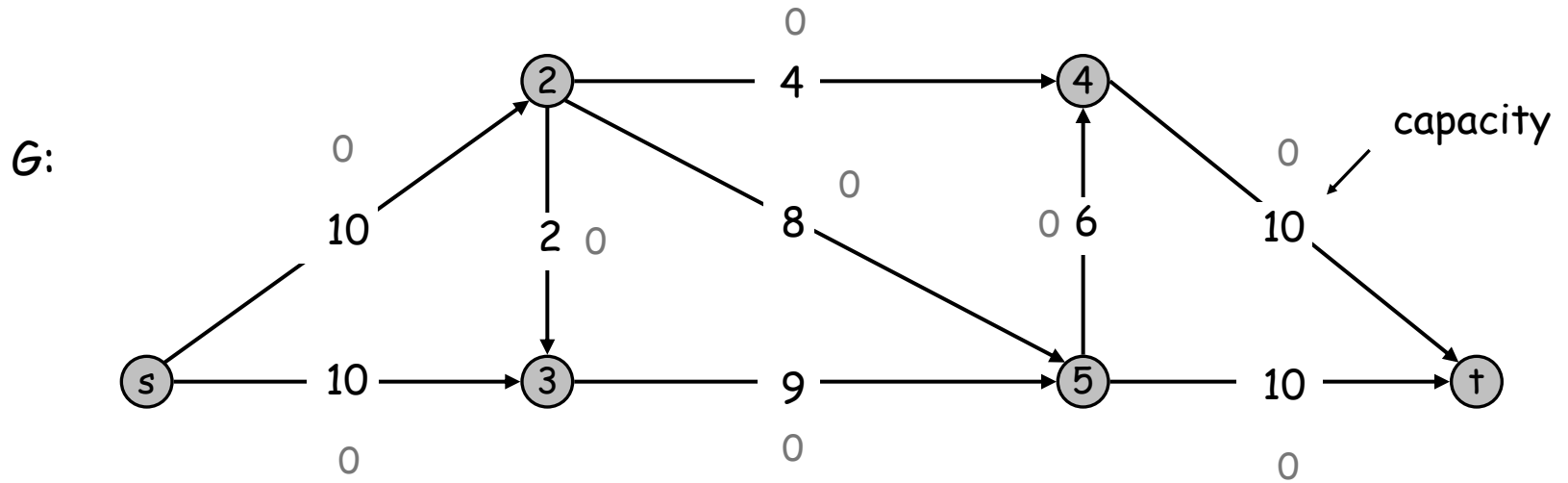

Ford-Fulkerson Algorithm

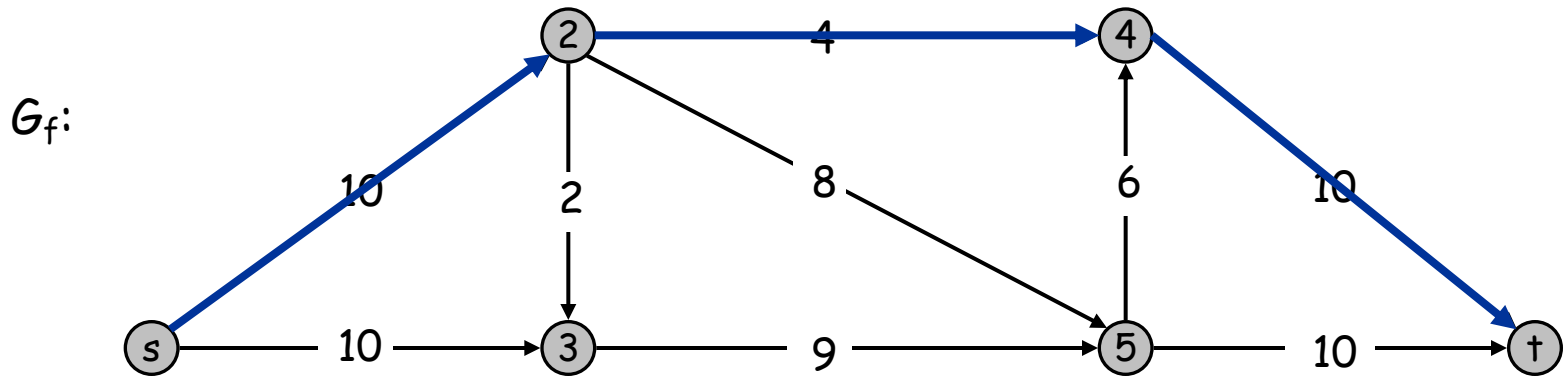
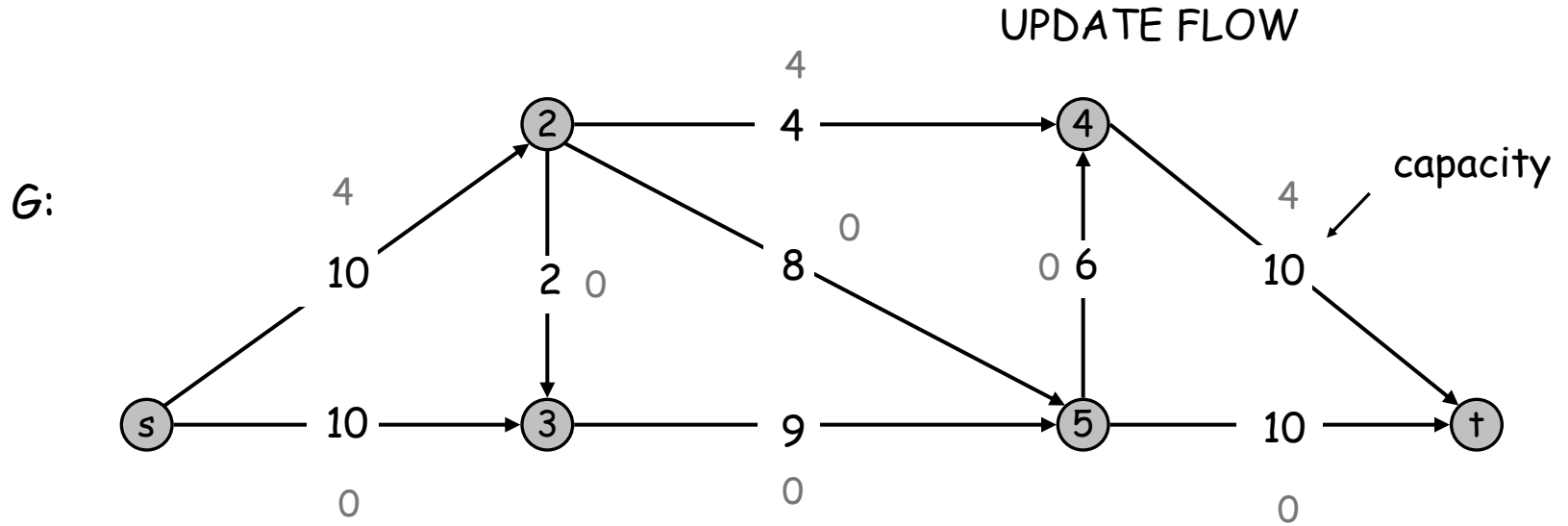

Ford-Fulkerson Algorithm

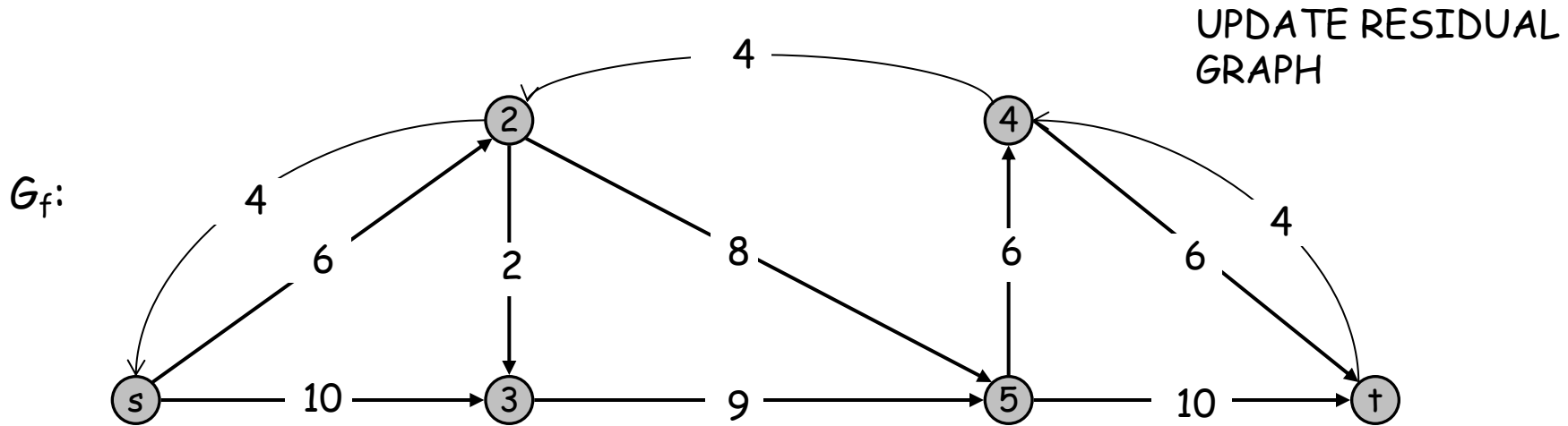
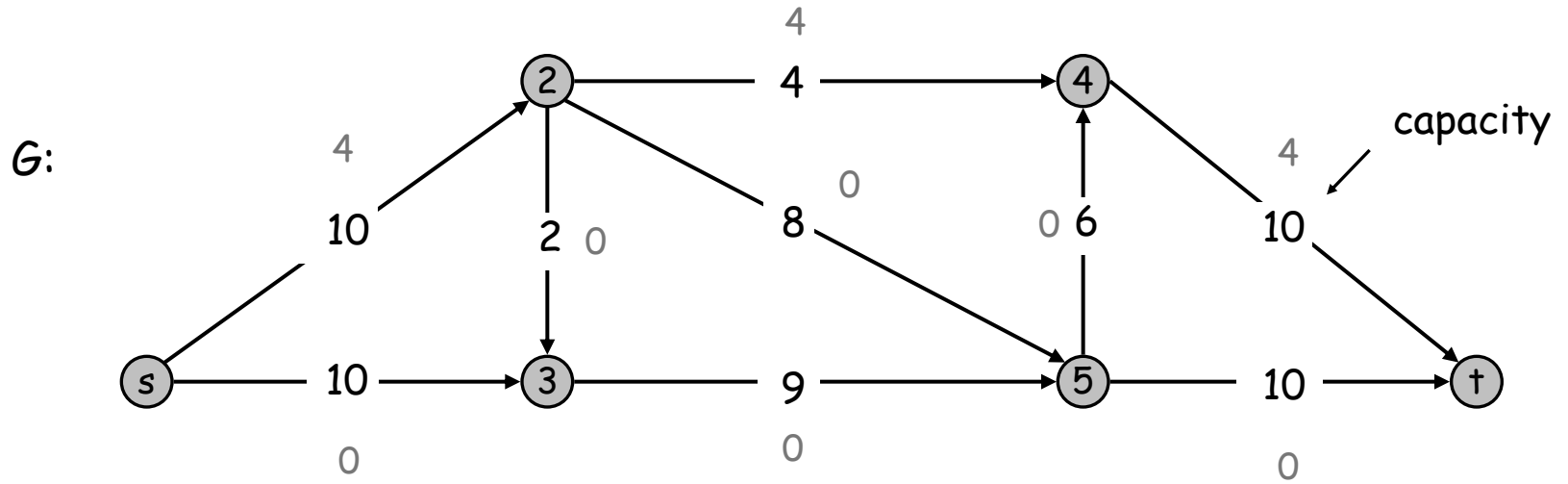

Ford-Fulkerson Algorithm

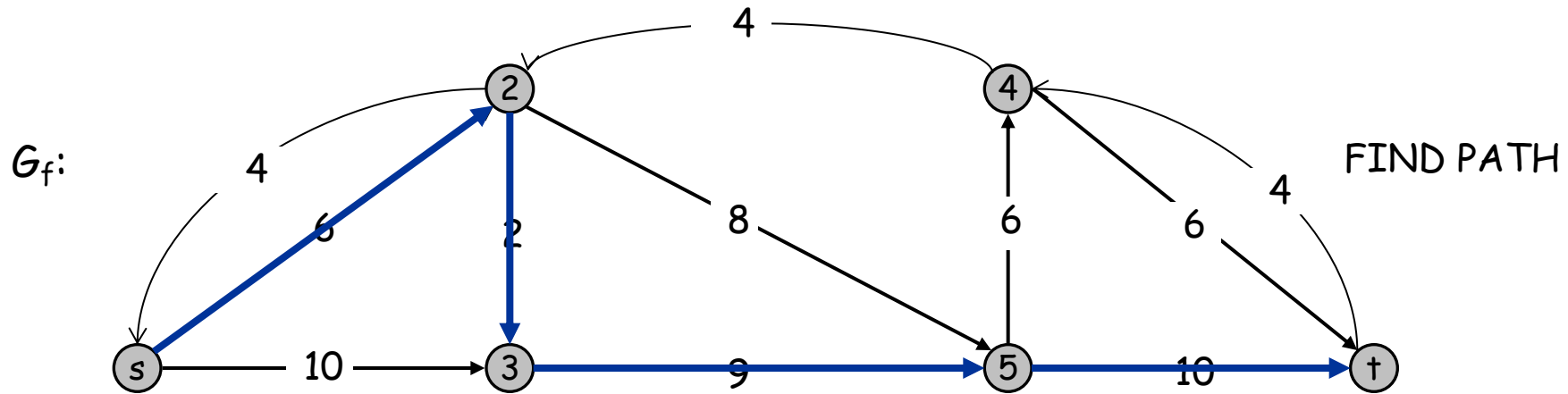
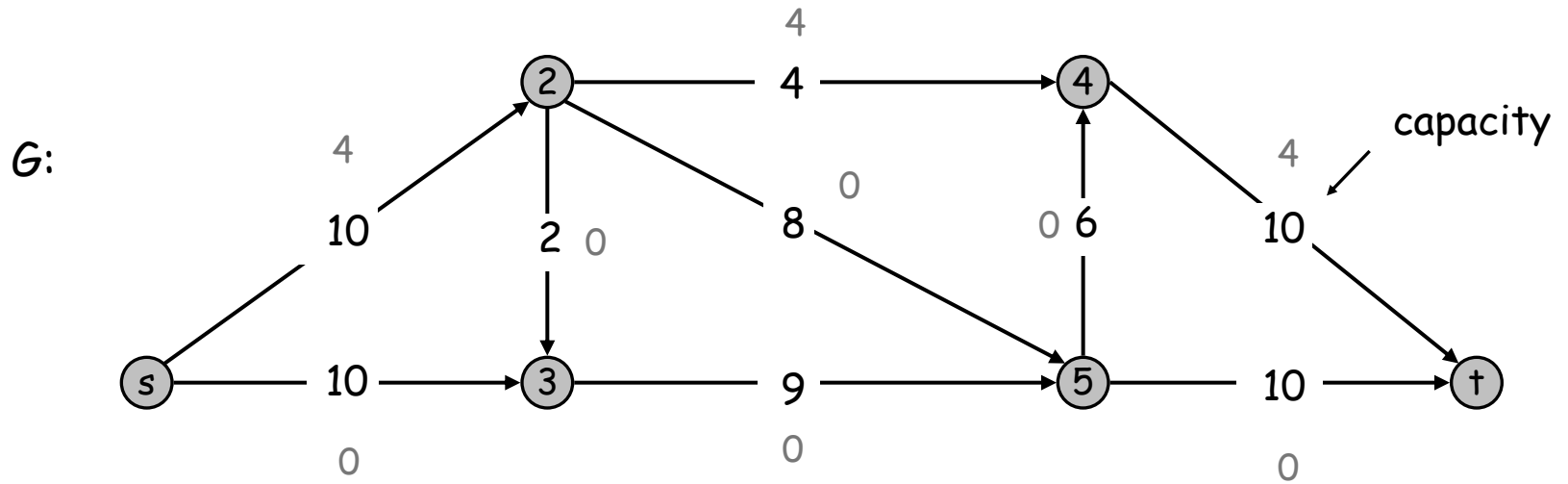

Ford-Fulkerson Algorithm

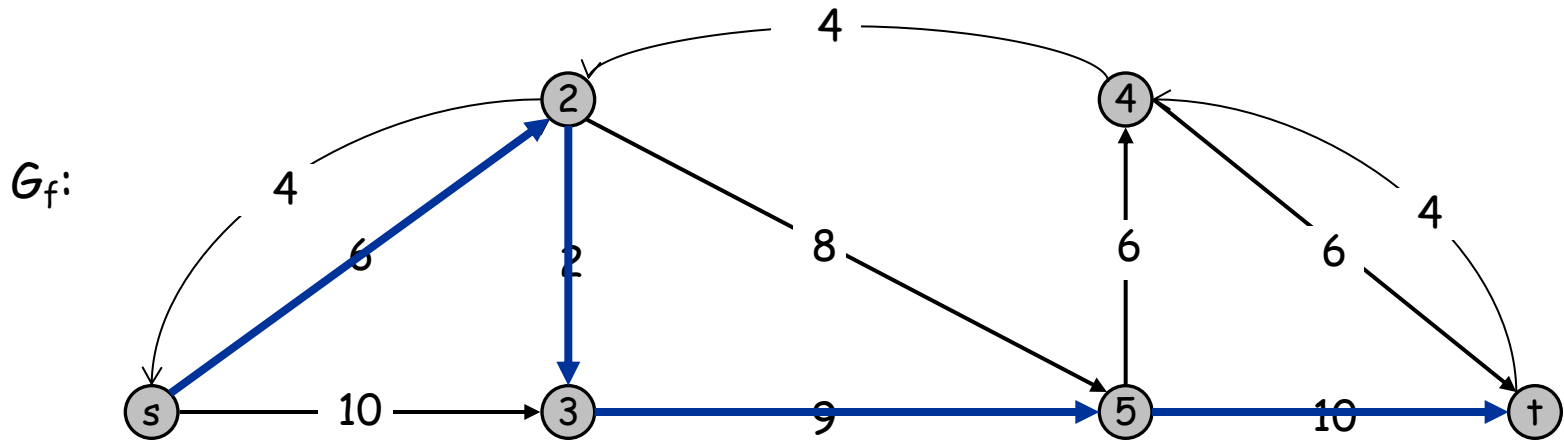
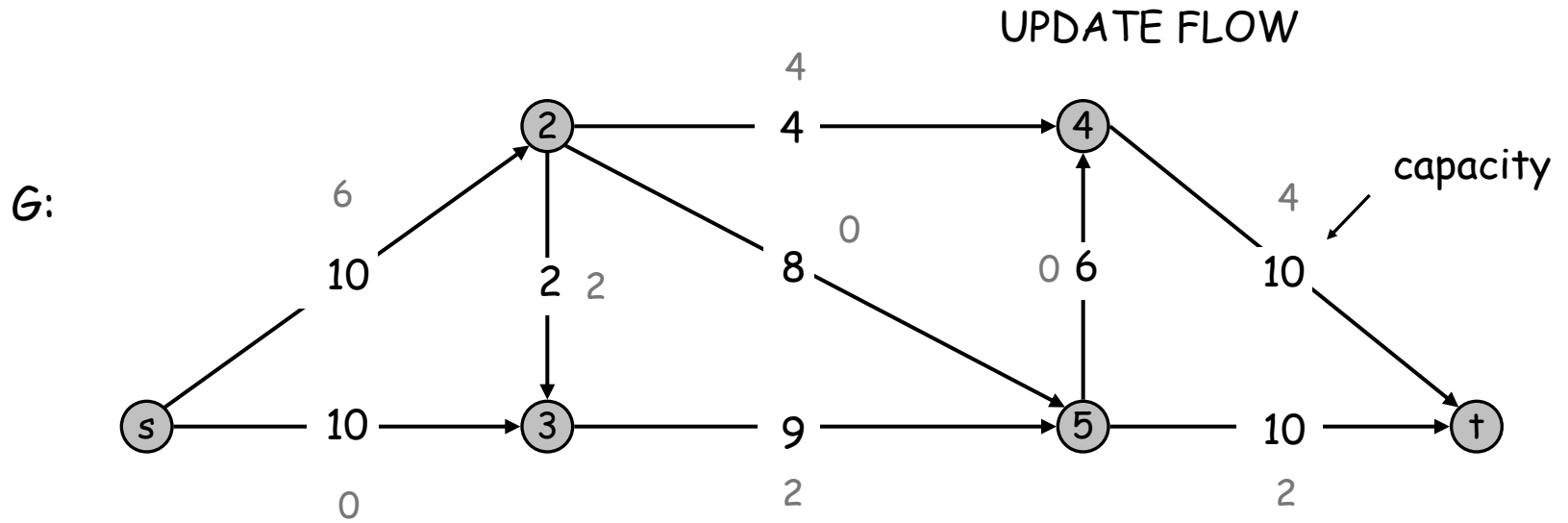

Ford-Fulkerson Algorithm

G :

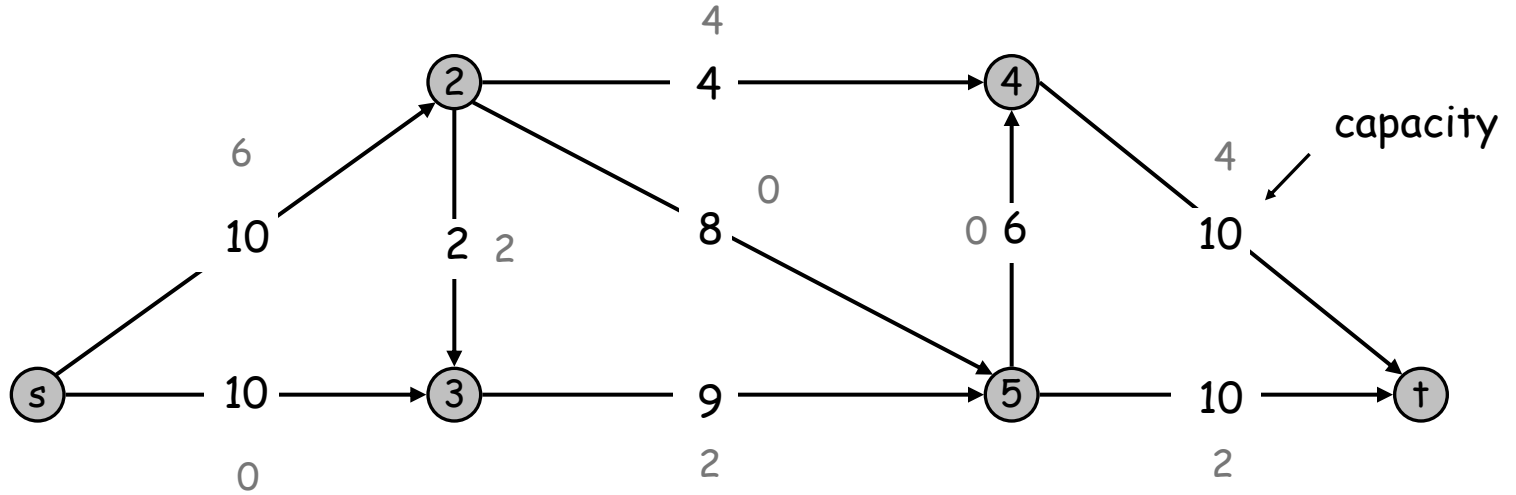

G_f :

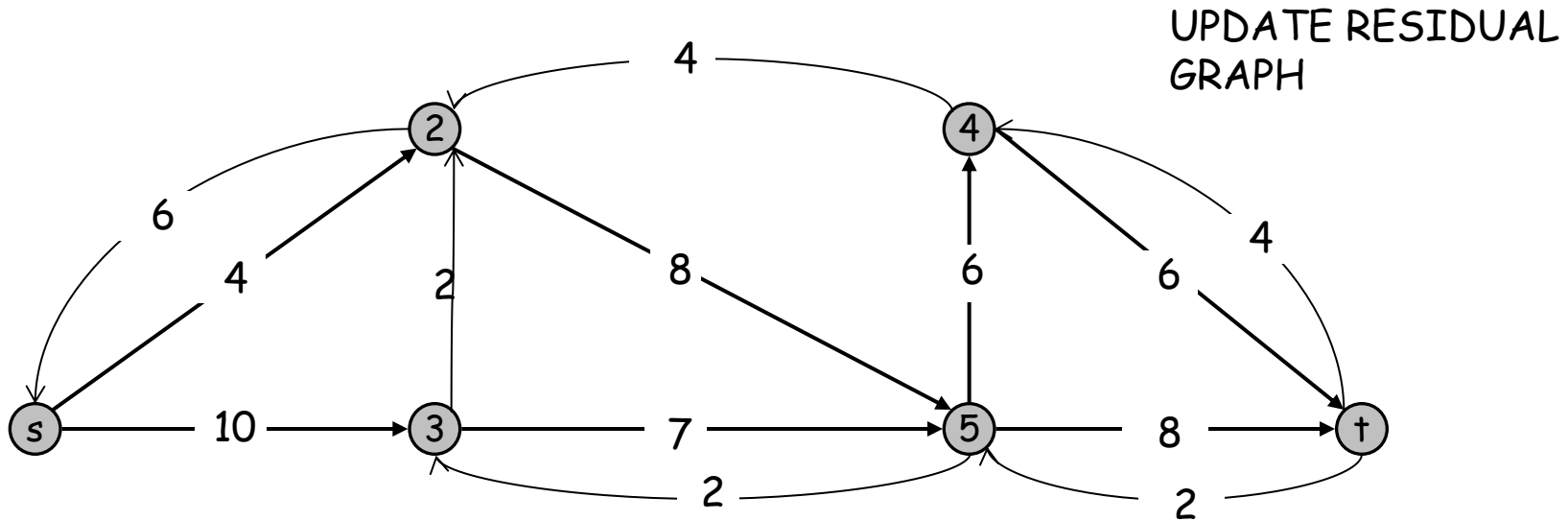

Ford-Fulkerson Algorithm

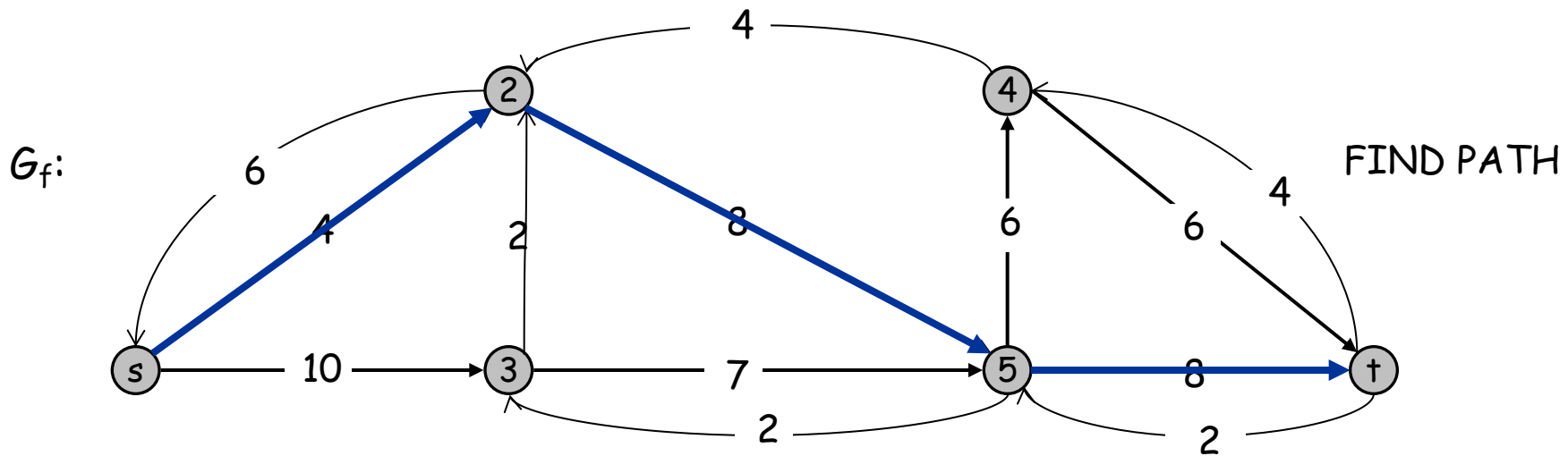
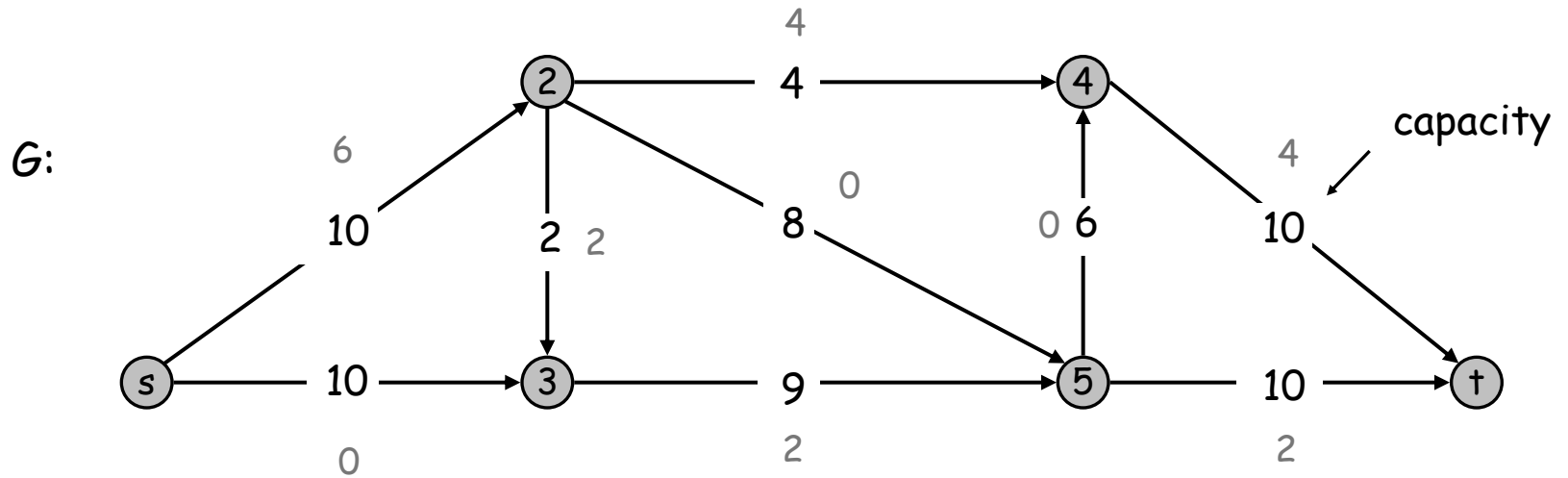

Ford-Fulkerson Algorithm

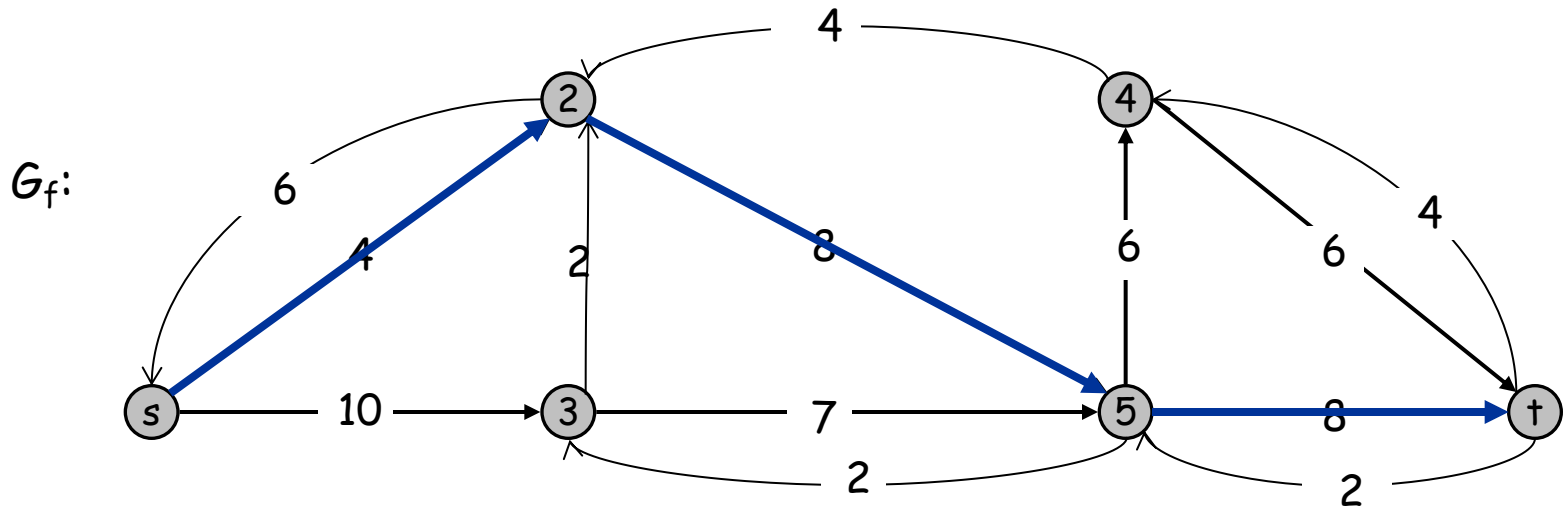
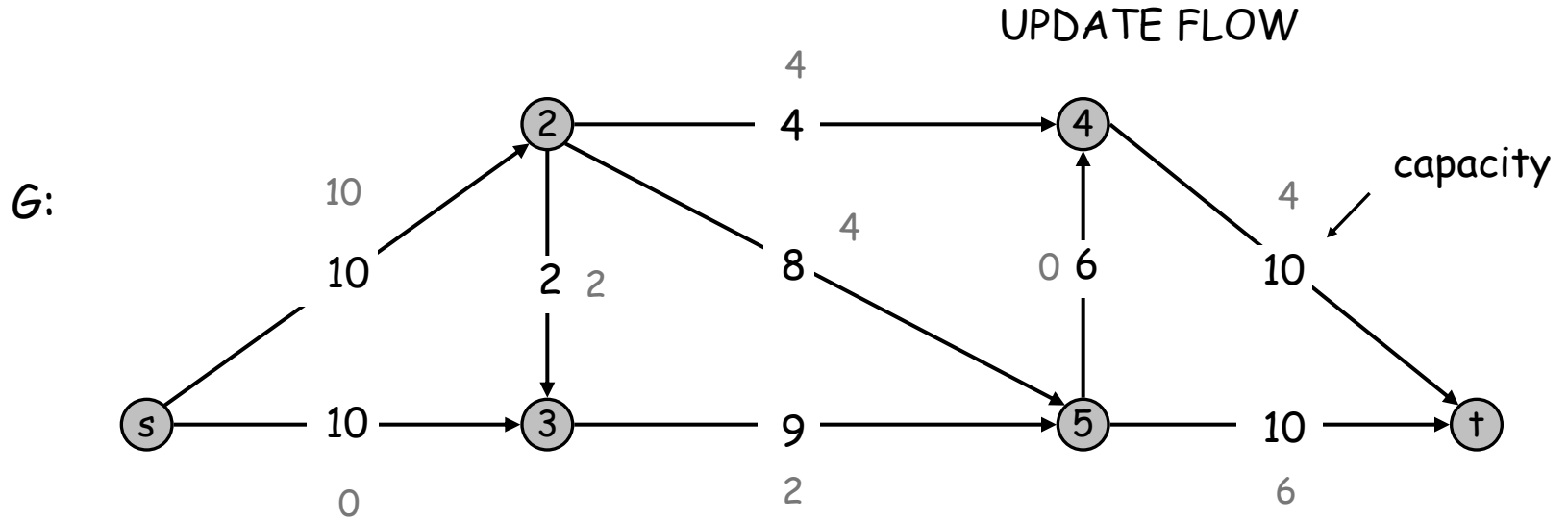

Ford-Fulkerson Algorithm

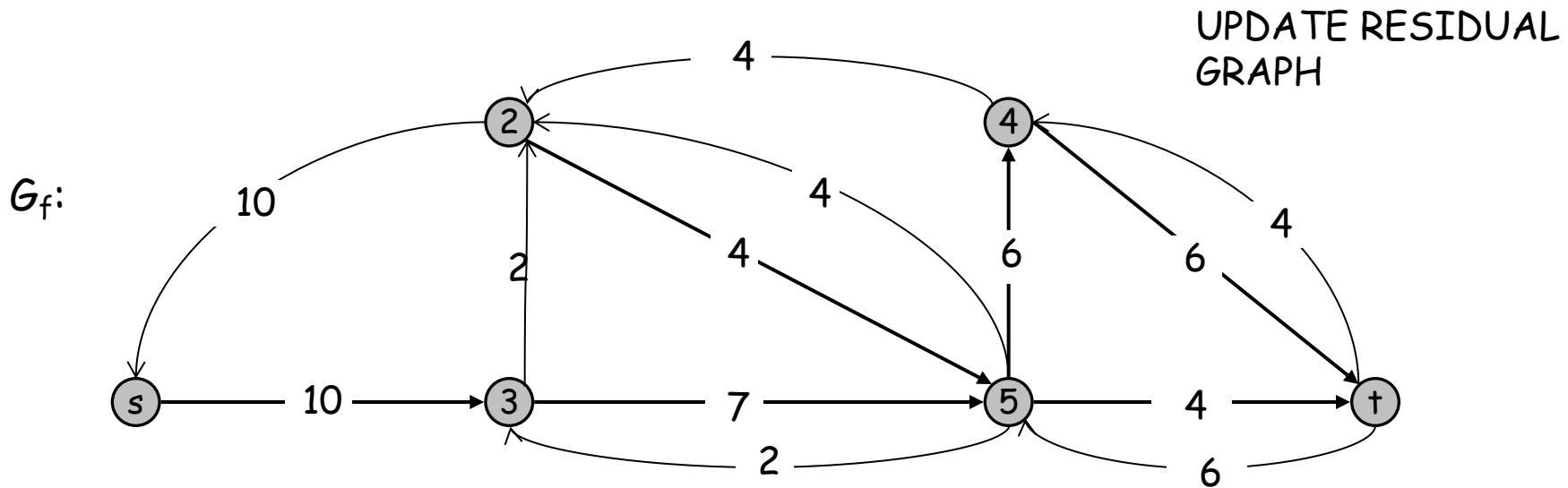
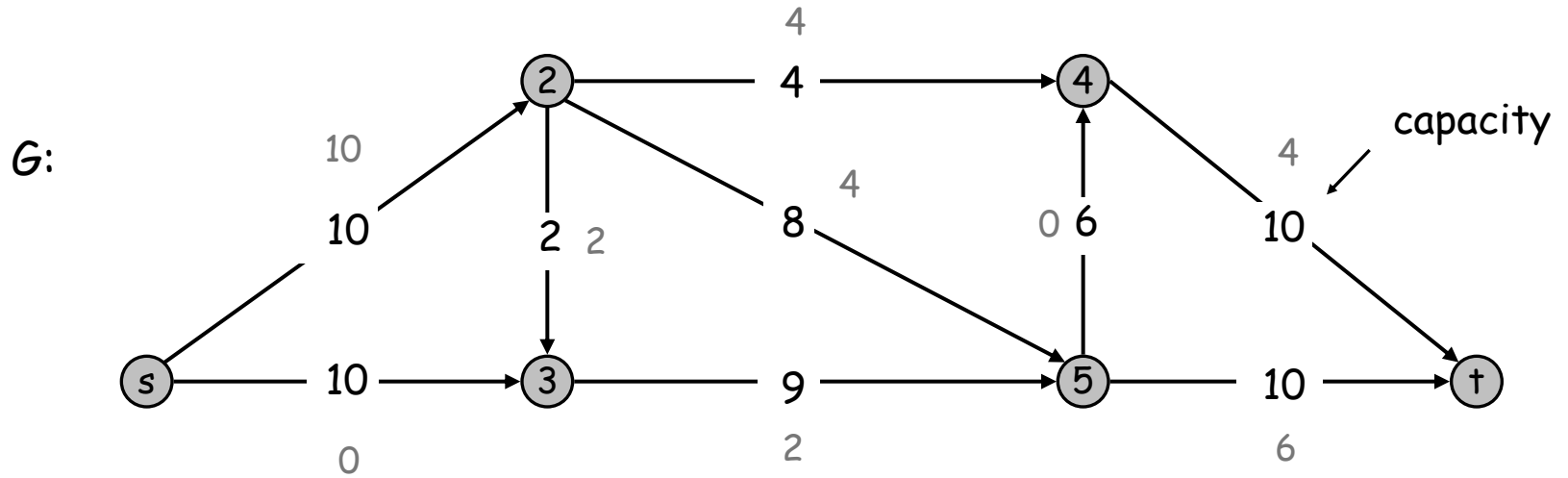

Ford-Fulkerson Algorithm

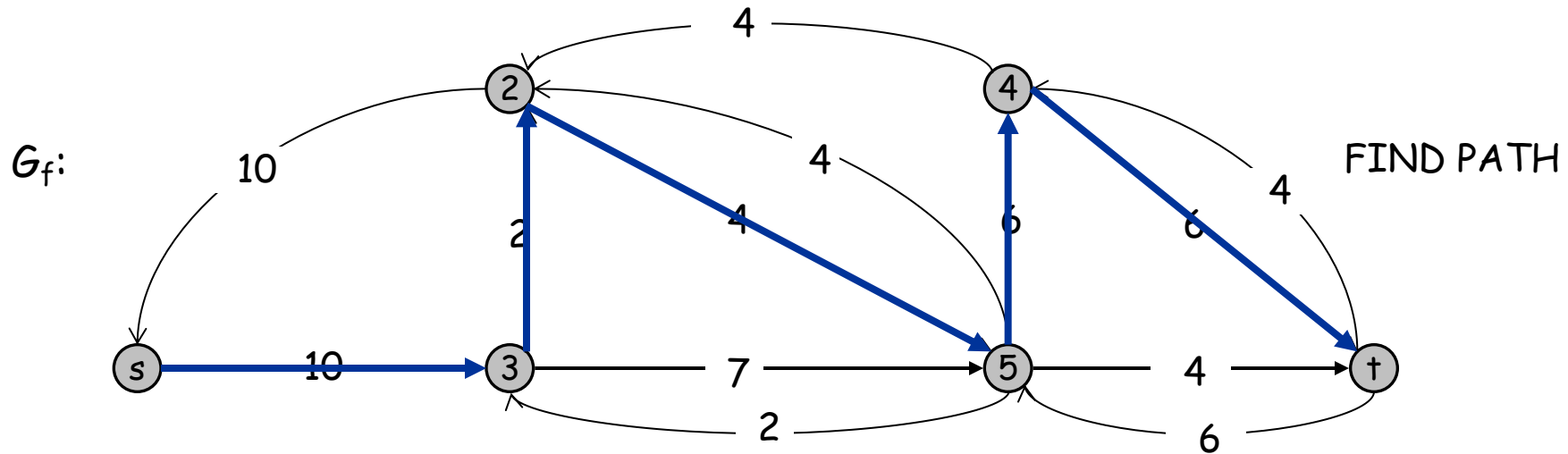
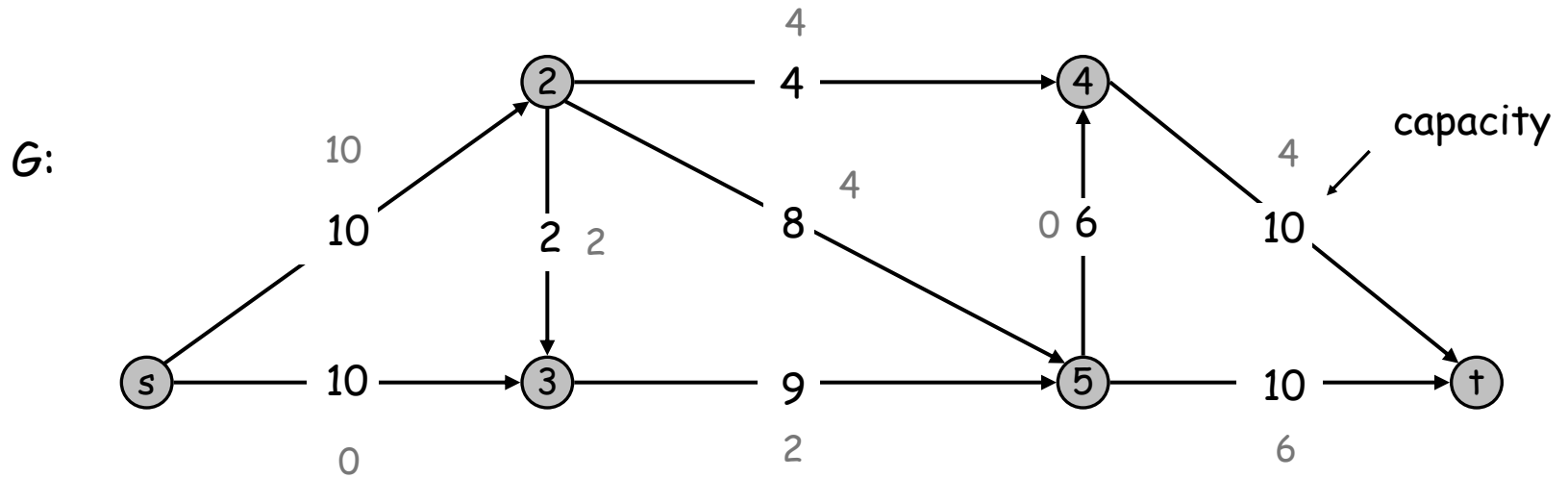

Ford-Fulkerson Algorithm

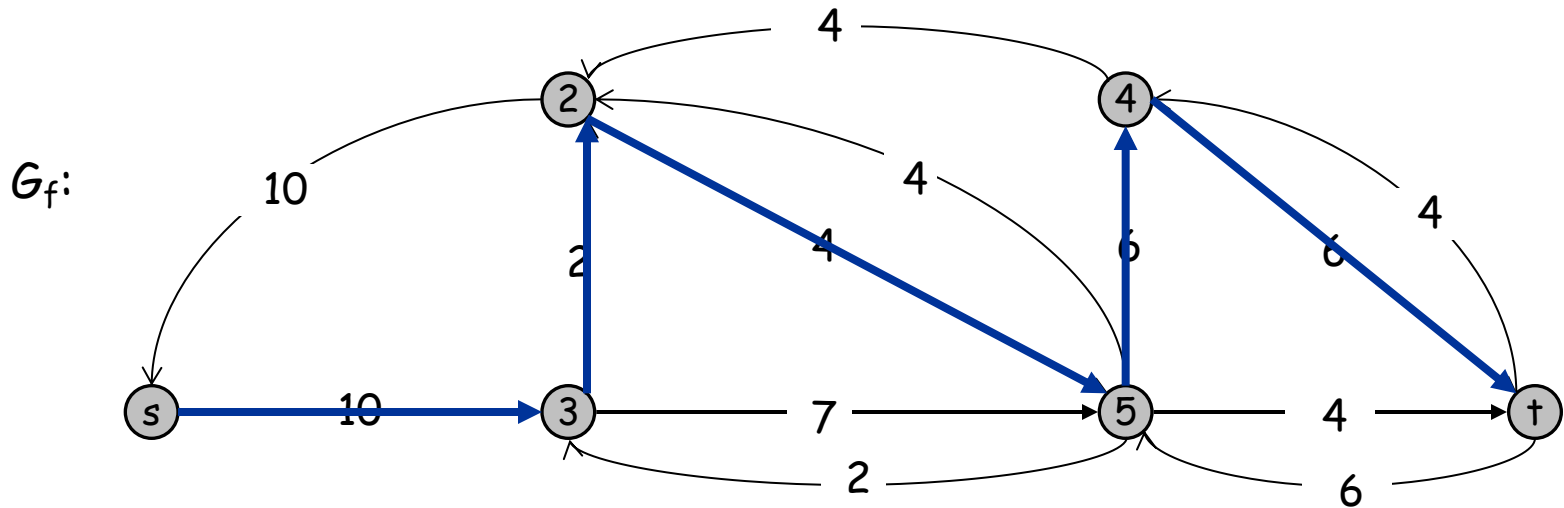
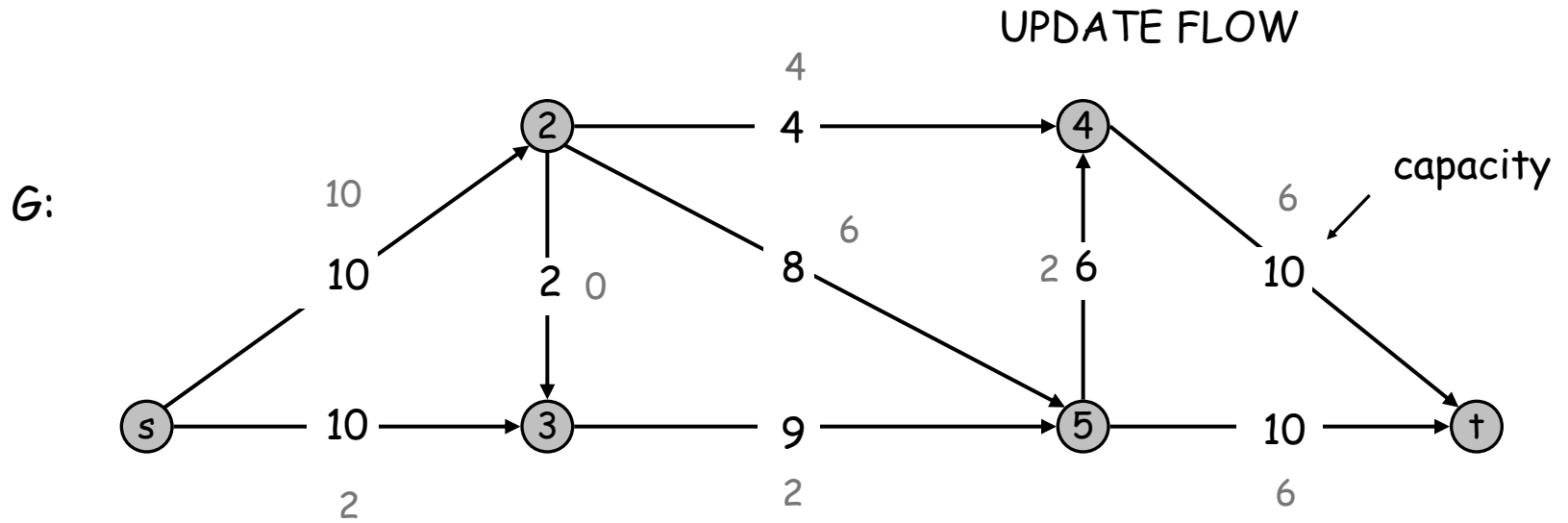

Ford-Fulkerson Algorithm

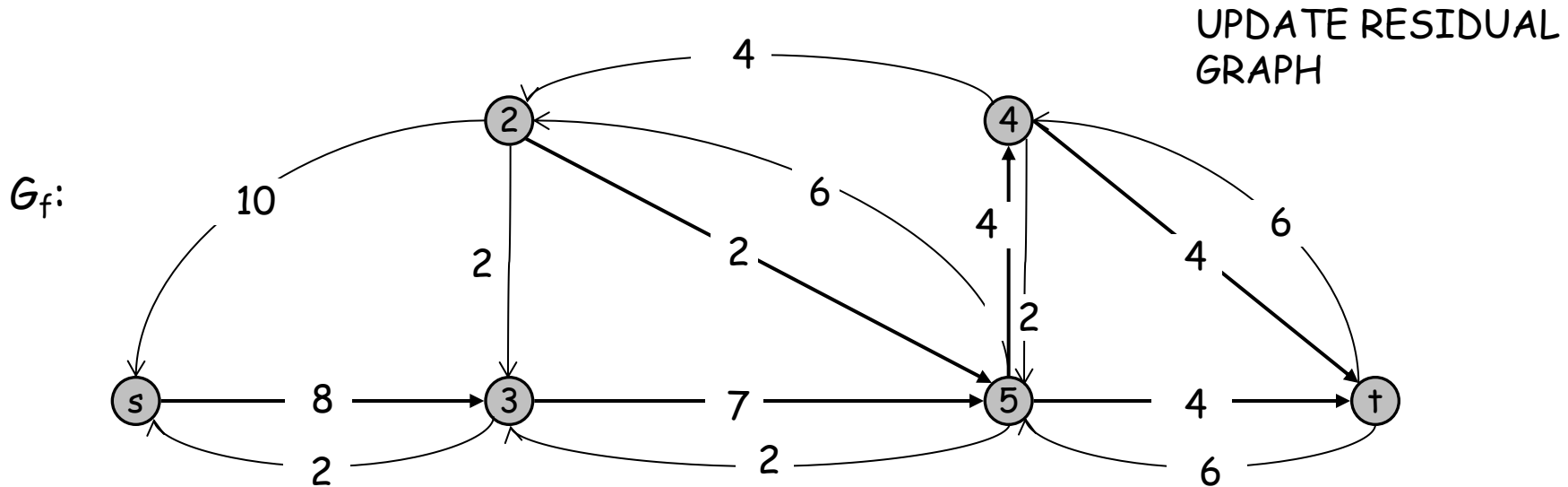
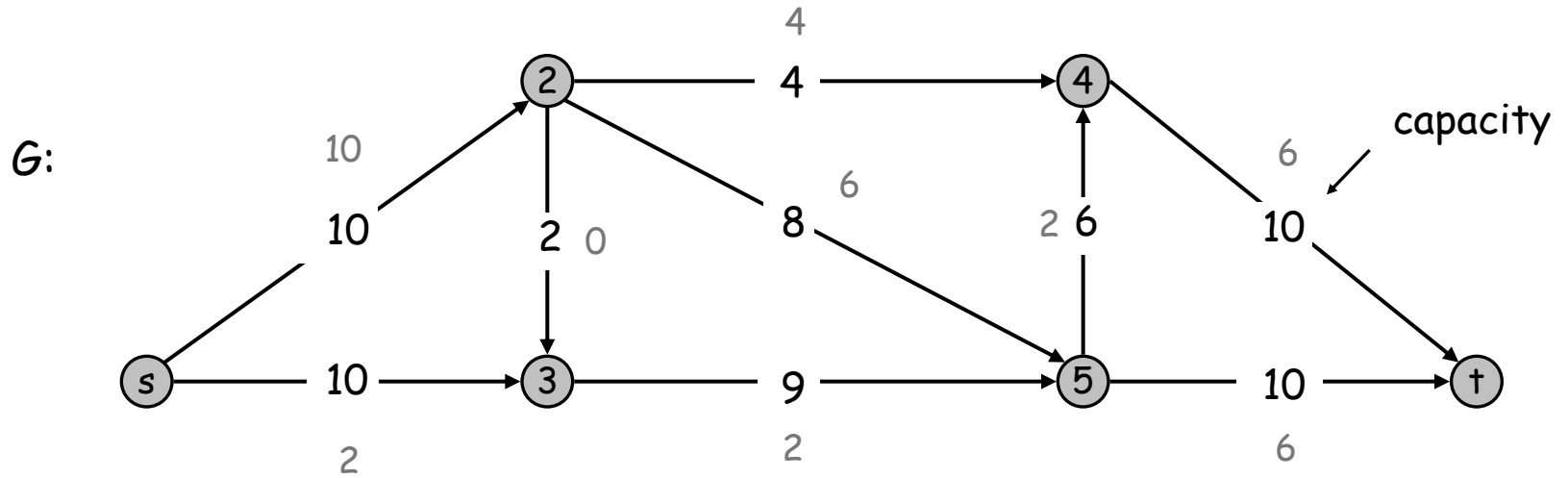

Ford-Fulkerson Algorithm

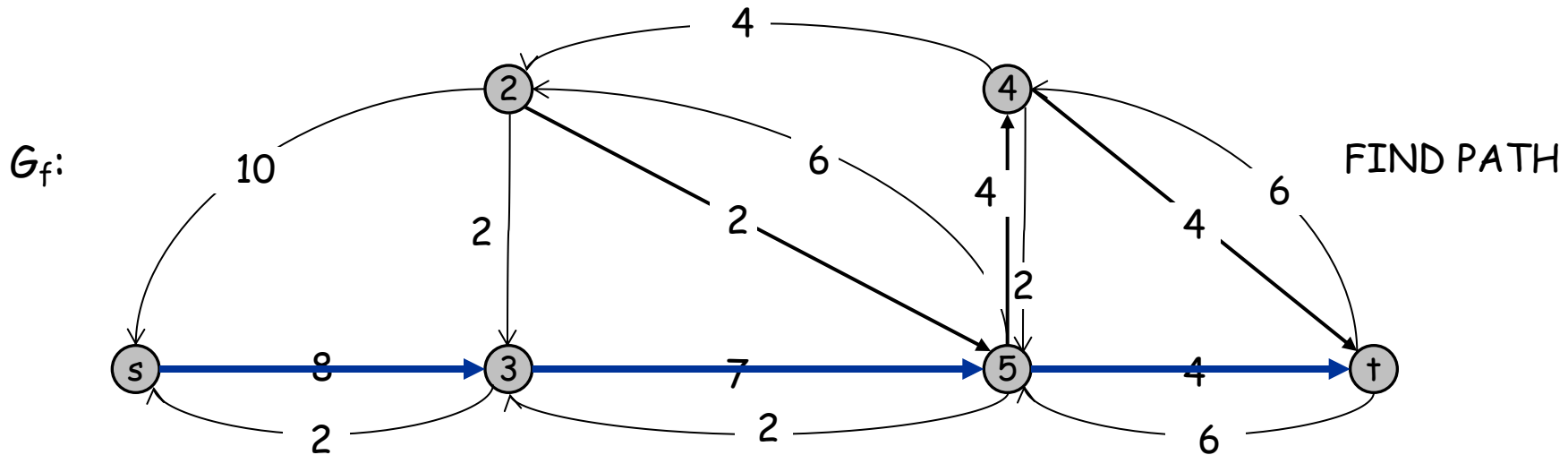
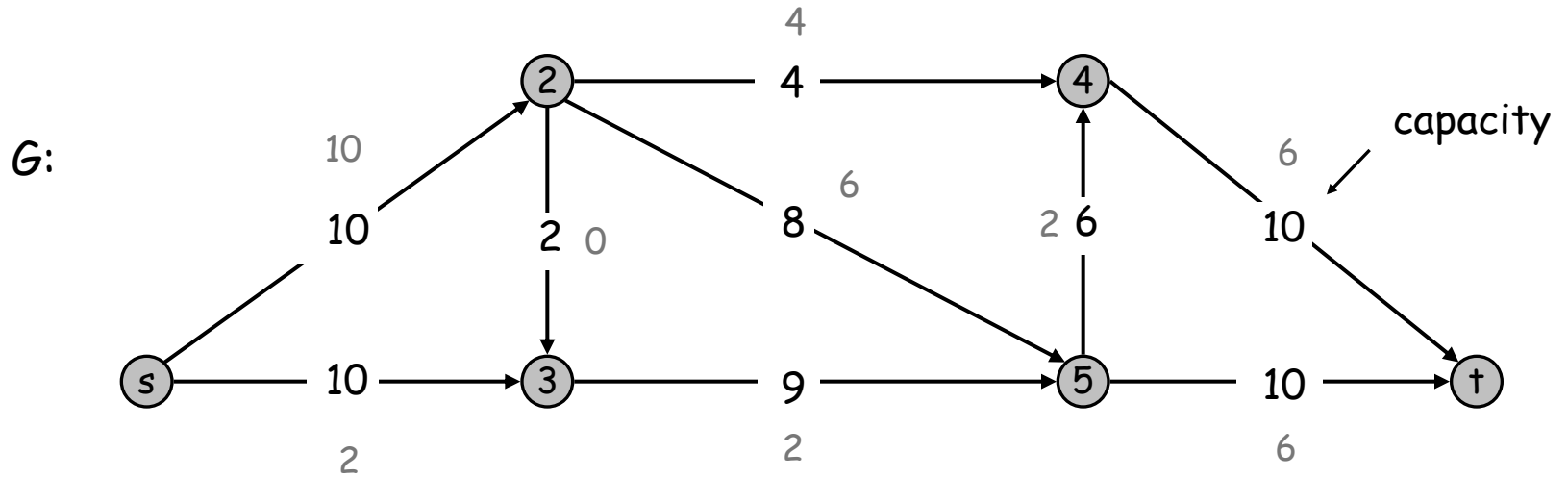

Ford-Fulkerson Algorithm

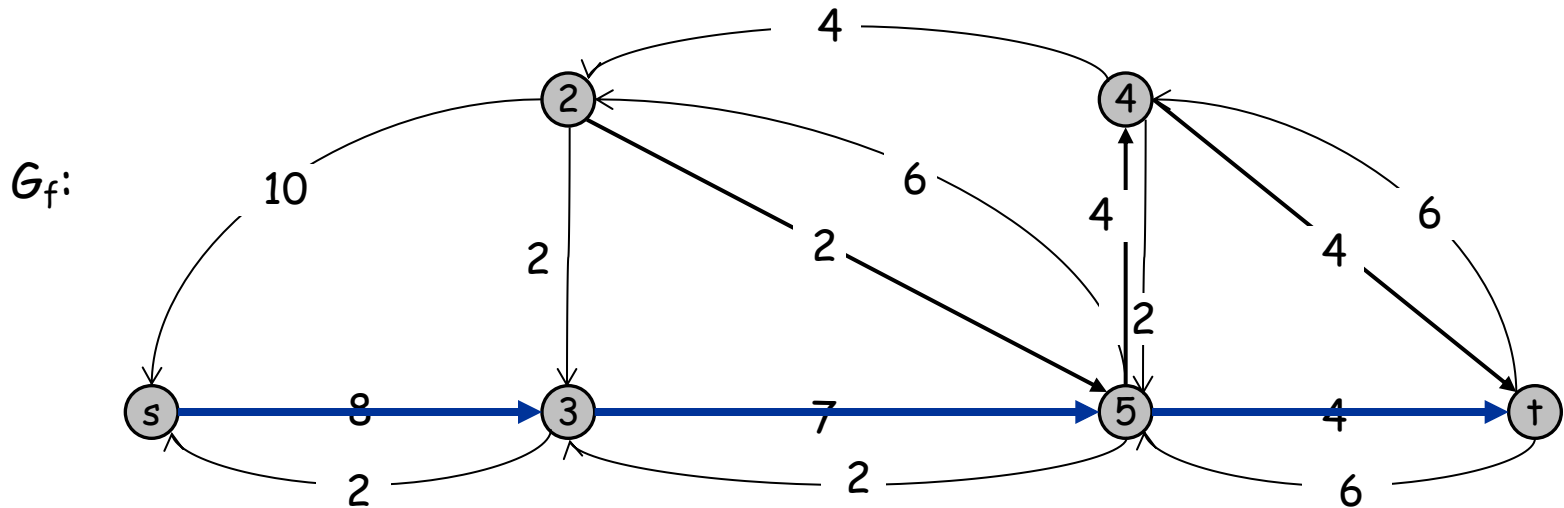
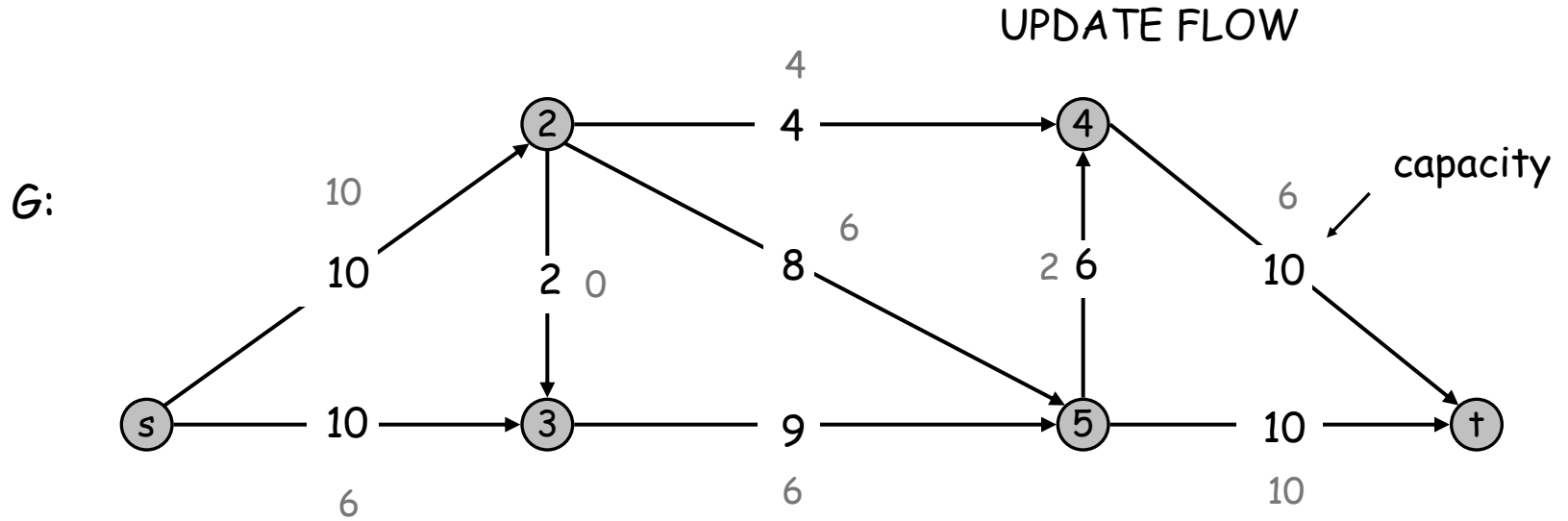

Ford-Fulkerson Algorithm

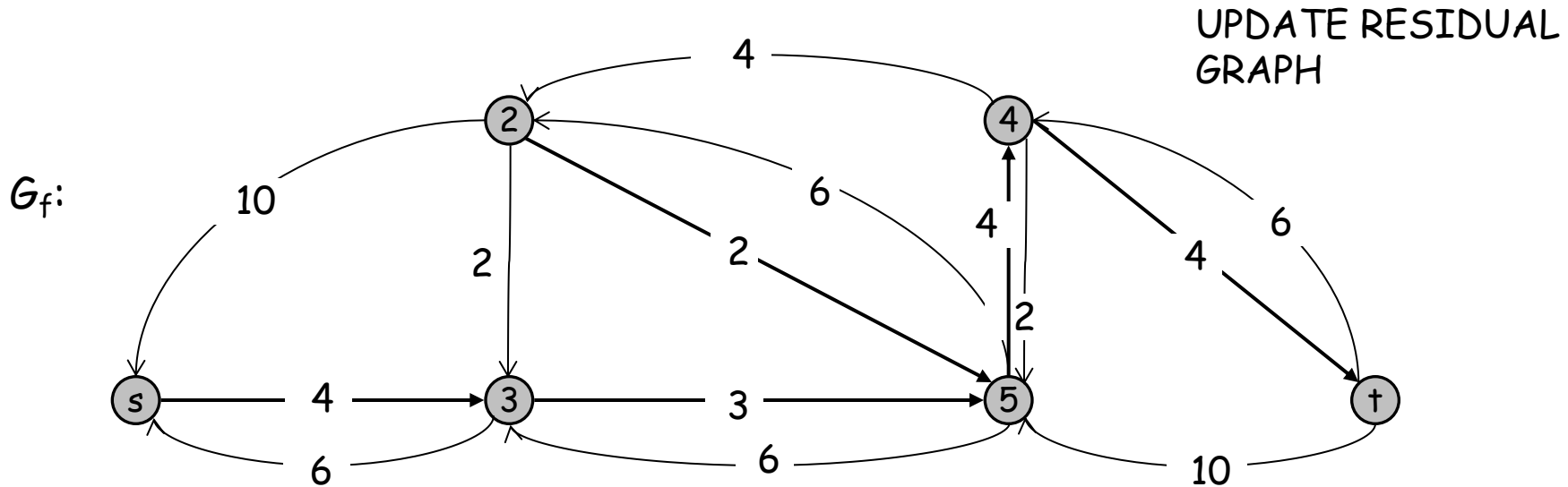
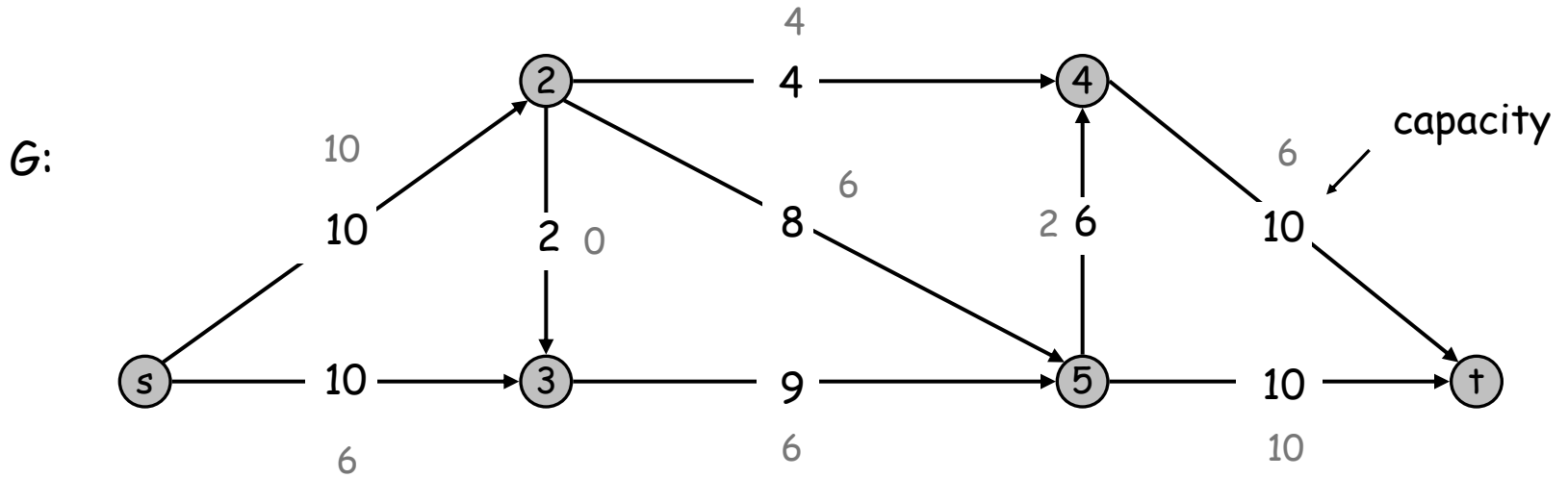

Ford-Fulkerson Algorithm

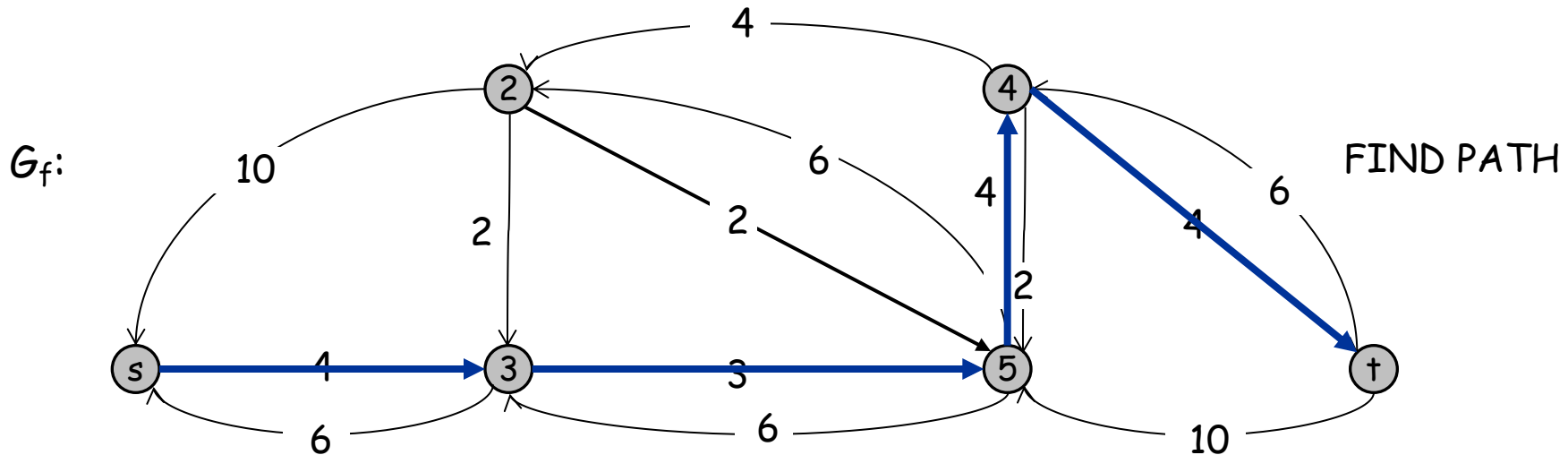
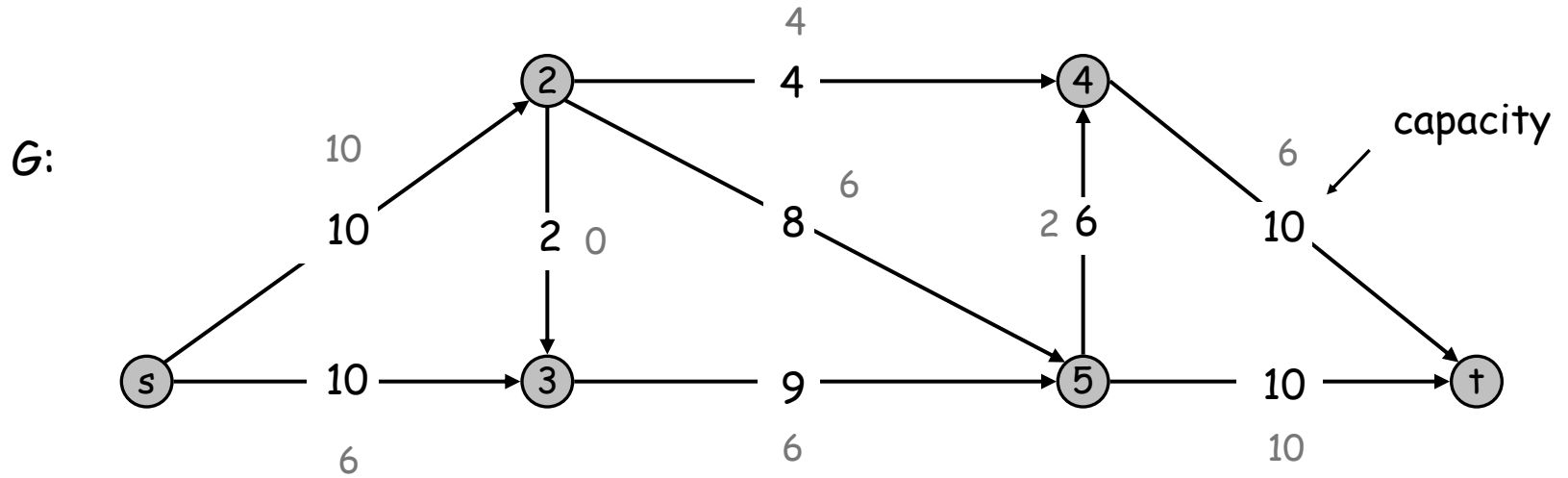

Ford-Fulkerson Algorithm

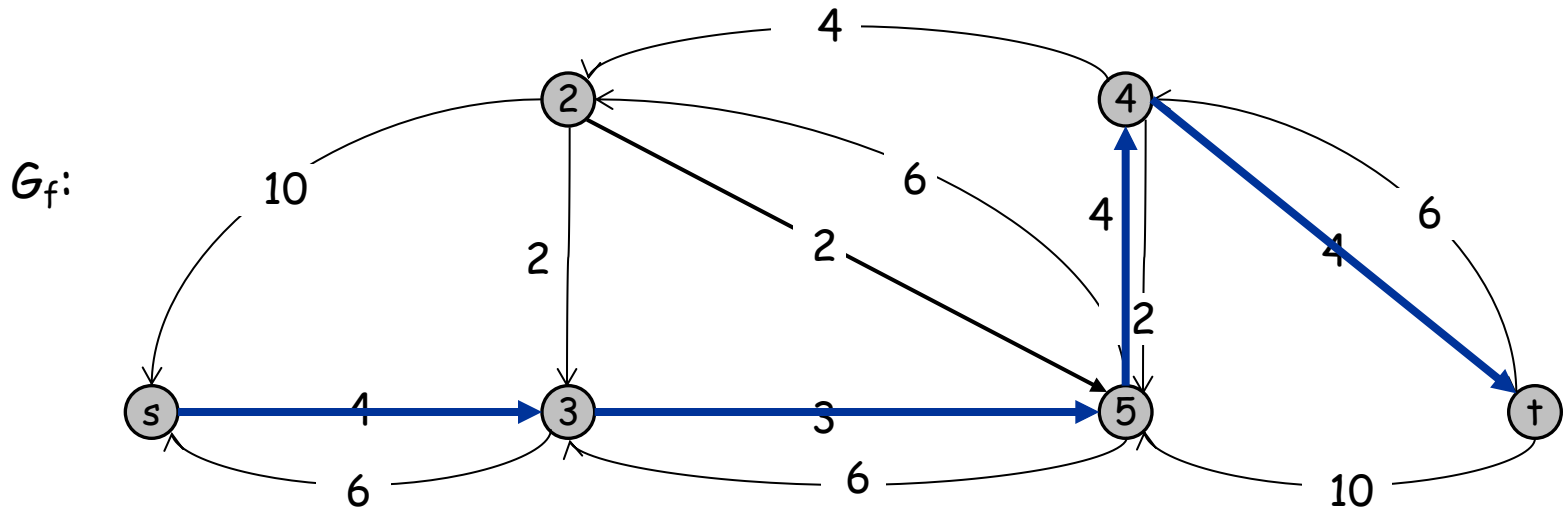
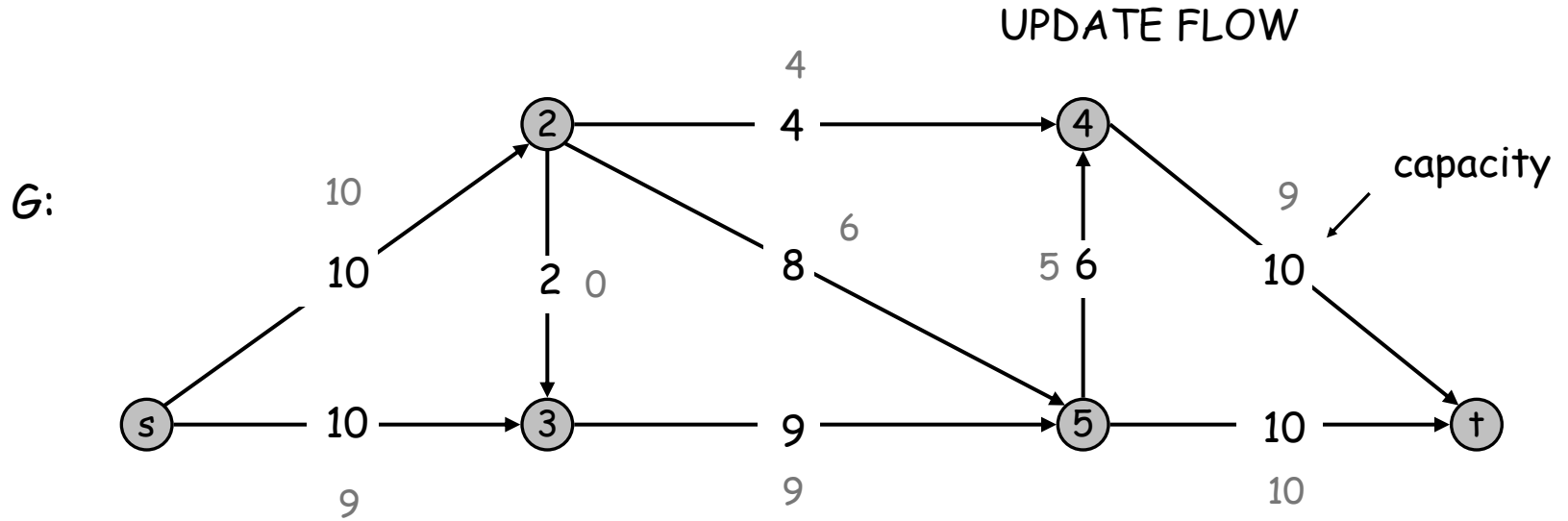

Ford-Fulkerson Algorithm

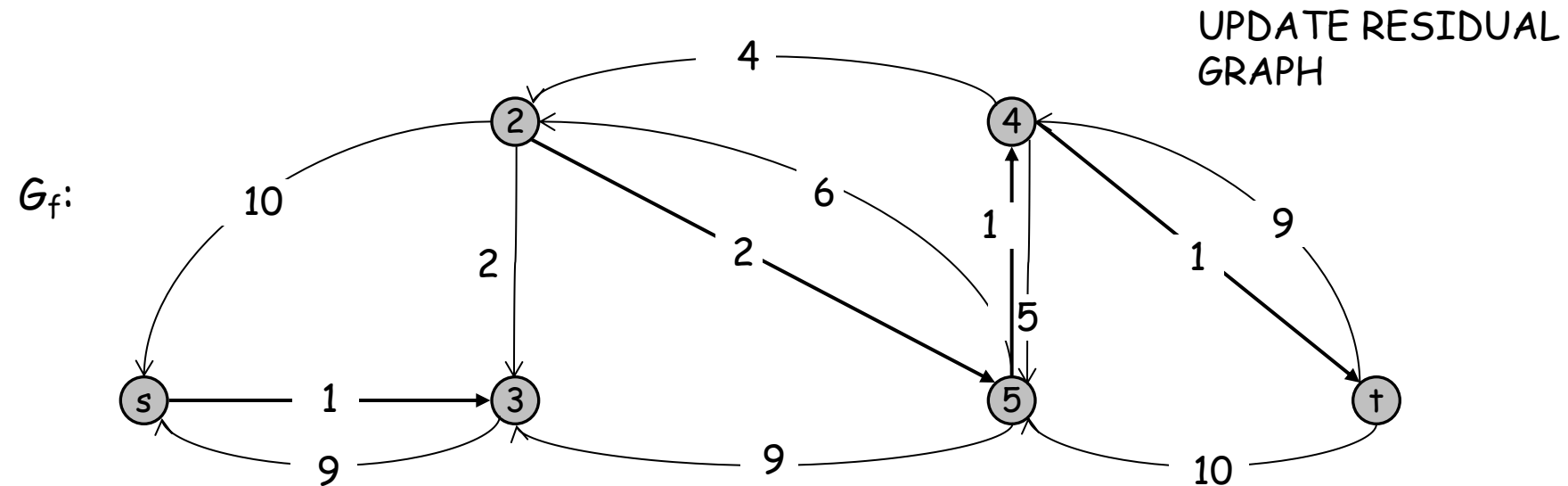
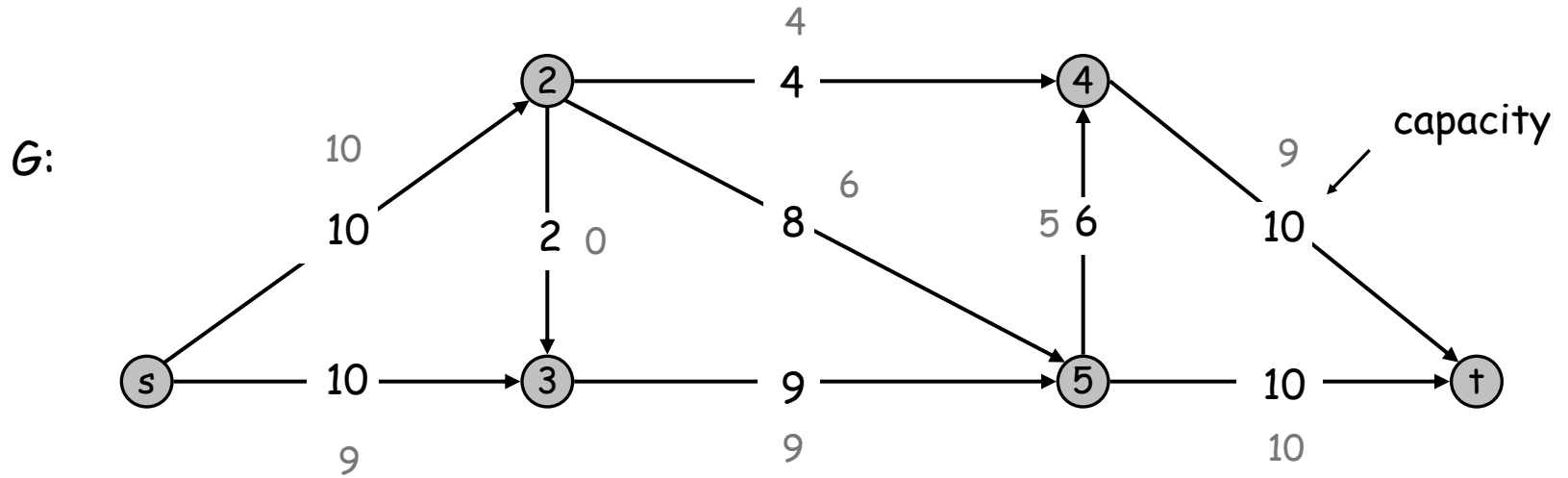

Ford-Fulkerson Algorithm

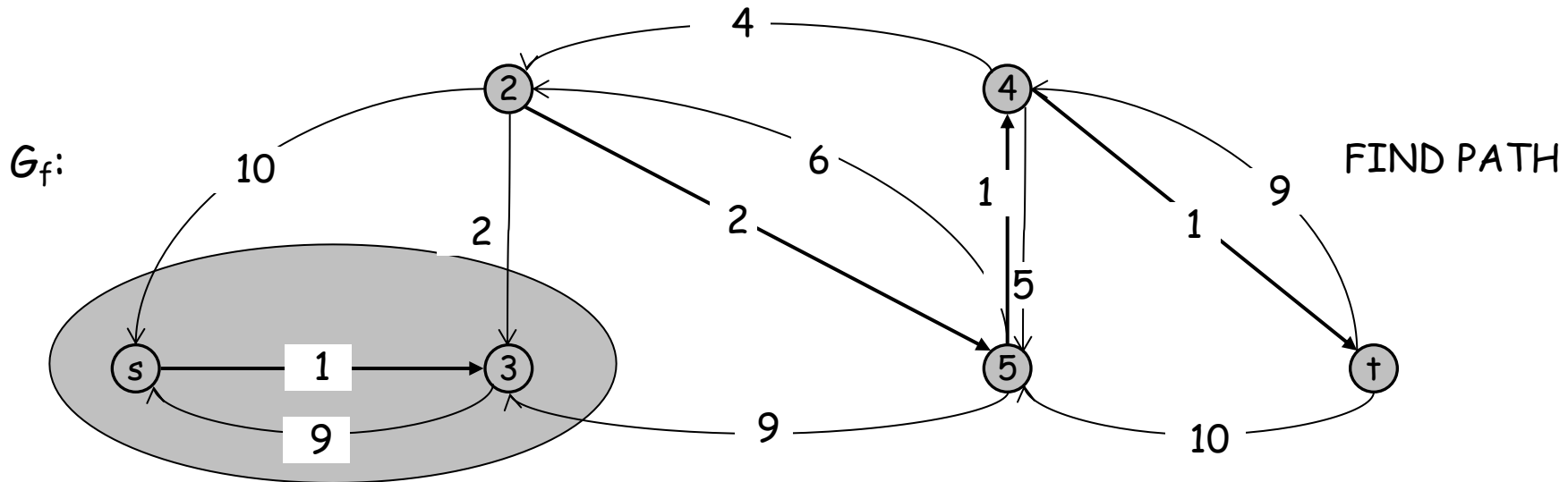
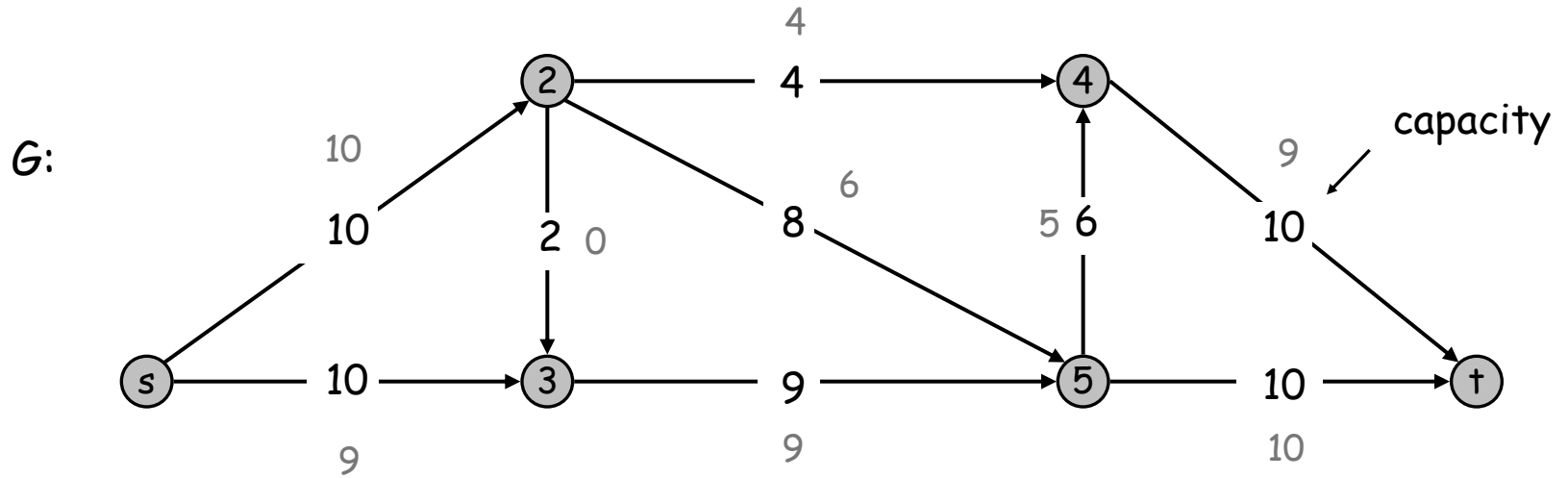

Augmenting Path Algorithm

```
Augment(f, c, P) {  
  b ← bottleneck(P)  
  foreach e ∈ P {  
    if (e ∈ E) f(e) ← f(e) + b  
    else      f(eR) ← f(e) - b  
  }  
  return f  
}
```

forward edge
reverse edge

```
Ford-Fulkerson(G, s, t, c) {  
  foreach e ∈ E f(e) ← 0  
  Gf ← residual graph  
  
  while (there exists augmenting path P) {  
    f ← Augment(f, c, P)  
    update Gf  
  }  
  return f  
}
```

Max-Flow Min-Cut Theorem

Augmenting path theorem. Flow f is a max flow iff there are no augmenting paths.

Max-flow min-cut theorem. [Ford-Fulkerson 1956] The value of the max flow is equal to the value of the min cut.

Proof strategy. We prove both simultaneously by showing the TFAE:

- (i) There exists a cut (A, B) such that $v(f) = \text{cap}(A, B)$.
- (ii) Flow f is a max flow.
- (iii) There is no augmenting path relative to f .

(i) \Rightarrow (ii) This was the corollary to weak duality lemma.

(ii) \Rightarrow (iii) We show contrapositive.

- Let f be a flow. If there exists an augmenting path, then we can improve f by sending flow along path.

Proof of Max-Flow Min-Cut Theorem

(iii) \Rightarrow (i)

- Let f be a flow with no augmenting paths.
- Let A be set of vertices reachable from s in residual graph.
- By definition of A , $s \in A$.
- By definition of f , $t \in A$.

$$\begin{aligned} v(f) &= \sum_{e \text{ out of } A} f(e) - \sum_{e \text{ in to } A} f(e) \\ &= \sum_{e \text{ out of } A} c(e) \\ &= \text{cap}(A, B) \quad \blacksquare \end{aligned}$$

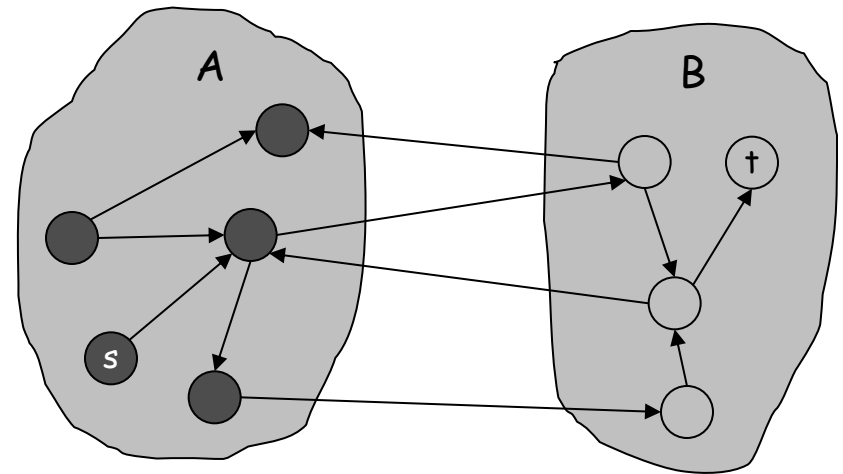

original network

Running Time

Assumption. All capacities are integers between 1 and C .

Invariant. Every flow value $f(e)$ and every residual capacities $c_f(e)$ remains an integer throughout the algorithm.

Theorem. The algorithm terminates in at most $v(f^*) \leq nC$ iterations, if f^* is optimal flow.

Pf. Each augmentation increase value by at least 1. ▸

Corollary. If $C = 1$, Ford-Fulkerson runs in $O(mn)$ time.

Integrality theorem. If all capacities are integers, then there exists a max flow f for which every flow value $f(e)$ is an integer.

Pf. Since algorithm terminates, theorem follows from invariant. ▸

7.3 Choosing Good Augmenting Paths

Ford-Fulkerson: Exponential Number of Augmentations

Q. Is generic Ford-Fulkerson algorithm polynomial in input size?

$m, n,$ and $\log C$ \nearrow

A. No. If max capacity is C , then algorithm can take C iterations.

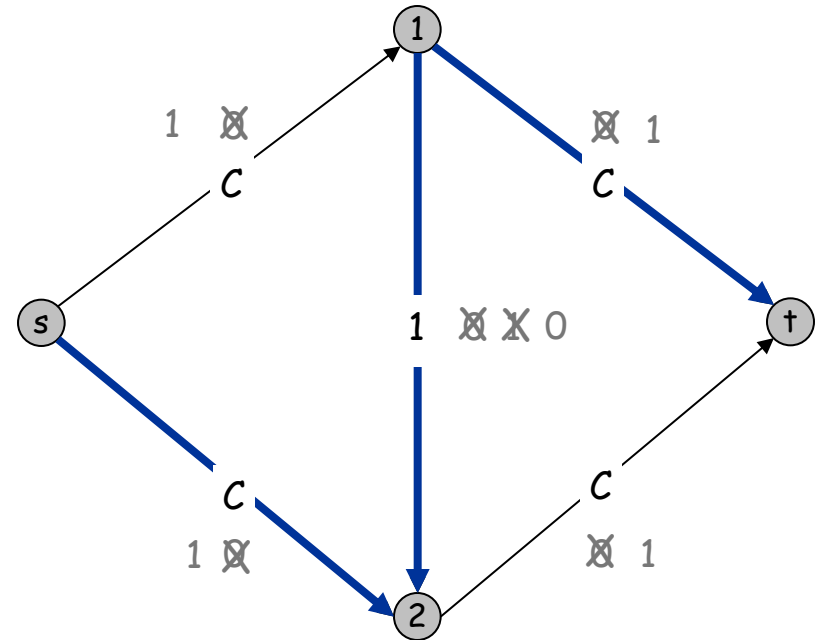
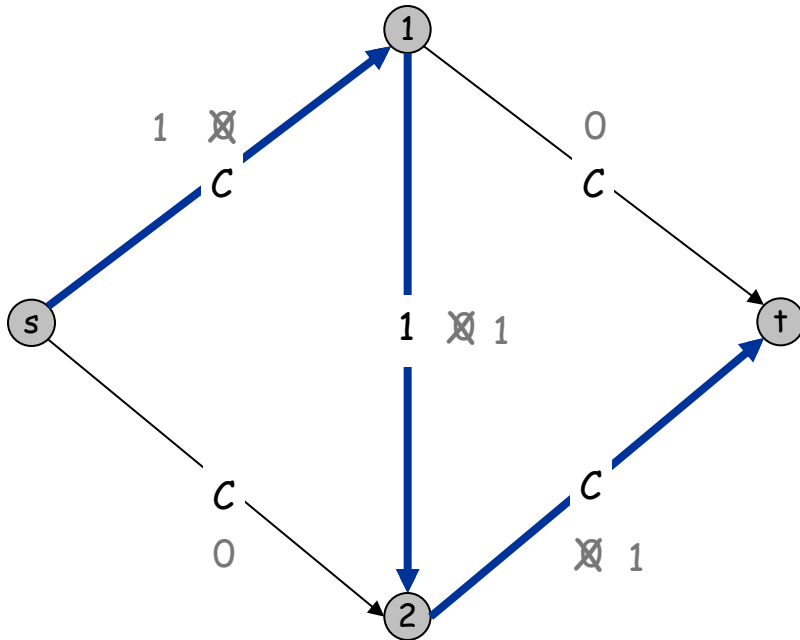

Choosing Good Augmenting Paths

Use care when selecting augmenting paths.

- Some choices lead to exponential algorithms.
- Clever choices lead to polynomial algorithms.

Goal: choose augmenting paths so that:

- Can find augmenting paths efficiently.
- Few iterations.

Choose augmenting paths with: [Edmonds-Karp 1972, Dinitz 1970]

- Max bottleneck capacity.
- Sufficiently large bottleneck capacity.
- Fewest number of edges.

Capacity Scaling

Intuition. Choosing path with highest bottleneck capacity increases flow by max possible amount.

- Don't worry about finding exact highest bottleneck path.
- Maintain scaling parameter δ .
- Let $G_f(\delta)$ be the subgraph of the residual graph consisting of only arcs with capacity at least δ .

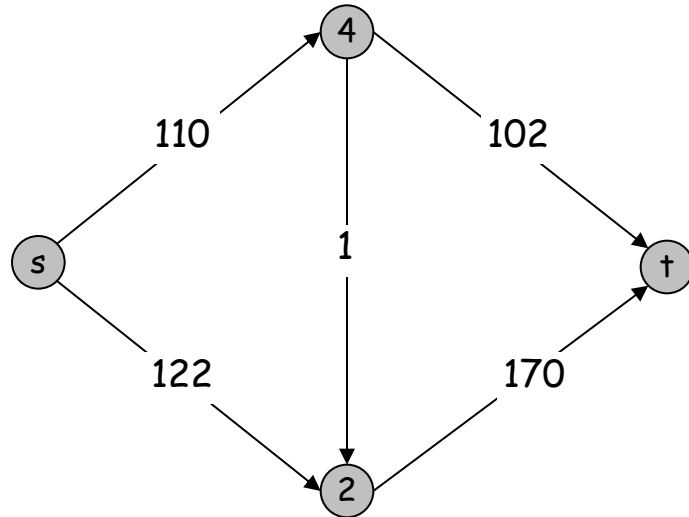

G_f

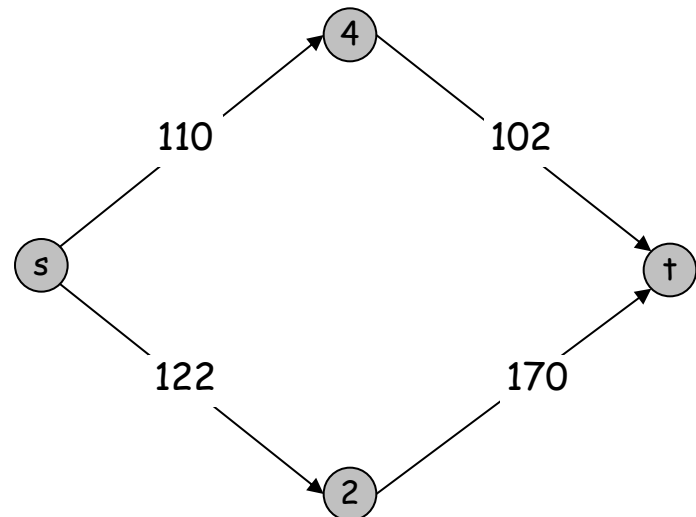

$G_f(100)$

Capacity Scaling

```
Scaling-Max-Flow( $G, s, t, c$ ) {  
  foreach  $e \in E$   $f(e) \leftarrow 0$   
   $\delta \leftarrow$  smallest power of 2 greater than or equal to  $C$   
   $G_f \leftarrow$  residual graph  
  
  while ( $\delta \geq 1$ ) {  
     $G_f(\delta) \leftarrow$   $\delta$ -residual graph  
    while (there exists augmenting path  $P$  in  $G_f(\delta)$ ) {  
       $f \leftarrow$  augment( $f, c, P$ )  
      update  $G_f(\delta)$   
    }  
     $\delta \leftarrow \delta / 2$   
  }  
  return  $f$   
}
```

Capacity Scaling: Correctness

Assumption. All edge capacities are integers between 1 and C .

Integrality invariant. All flow and residual capacity values are integral.

Correctness. If the algorithm terminates, then f is a max flow.

Pf.

- By integrality invariant, when $\delta = 1$, $G_f(\delta) = G_f$.
- Upon termination of $\delta = 1$ phase, there are no augmenting paths. ·

Capacity Scaling: Running Time

Lemma 1. The outer while loop repeats $1 + \log_2 Cn$ times.

Pf. Initially $\delta < 2Cn$. δ decreases by a factor of 2 each iteration. •

Lemma 2. Let f be the flow at the end of a δ -scaling phase. Then the value of the maximum flow is at most $v(f) + m \delta$. ← proof on next slide

Lemma 3. There are at most $2m$ augmentations per scaling phase.

- Let f be the flow at the end of the previous scaling phase.
- L2 implies $v(f^*) \leq v(f) + m (2\delta)$.
- Each augmentation in a δ -phase increases $v(f)$ by at least δ . •

Theorem. The scaling max-flow algorithm finds a max flow in $O(m \log C)$ augmentations. It can be implemented to run in $O(m^2 \log C)$ time, when $m \gg n$. •

Capacity Scaling: Running Time

Lemma 2. Let f be the flow at the end of a δ -scaling phase. Then value of the maximum flow is at most $v(f) + m \delta$.

Pf. (almost identical to proof of max-flow min-cut theorem)

- We show that at the end of a δ -phase, there exists a cut (A, B) such that $\text{cap}(A, B) \leq v(f) + m \delta$.
- Choose A to be the set of nodes reachable from s in $G_f(\delta)$.
- By definition of A , $s \in A$.
- By definition of f , t not in A .

$$\begin{aligned}
 v(f) &= \sum_{e \text{ out of } A} f(e) - \sum_{e \text{ in to } A} f(e) \\
 &\geq \sum_{e \text{ out of } A} (c(e) - \delta) - \sum_{e \text{ in to } A} \delta \\
 &= \sum_{e \text{ out of } A} c(e) - \sum_{e \text{ out of } A} \delta - \sum_{e \text{ in to } A} \delta \\
 &\geq \text{cap}(A, B) - m\delta
 \end{aligned}$$

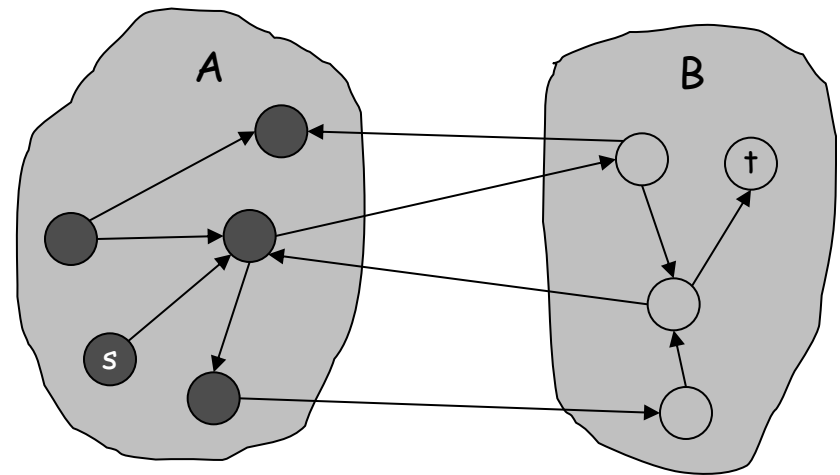

original network