

# REACT: A Framework for Rapid Exploration of Approximate Computing Techniques

Mark Wyse, André Baixo, Thierry Moreau, Bill Zorn  
James Bornholt, Adrian Sampson, Luis Ceze, Mark Oskin

University of Washington

# Motivation

Understand current research

Investigate new techniques

Evaluate impact of existing techniques

# Overview

## Taxonomy

Dimensions  
Conclusions

## Framework

Details  
Early Results

# Taxonomy

Determinism

$$|P(x) - A(x)| \leq \varepsilon \forall x$$
$$\Pr(|P(x) - A(x)| > \varepsilon) < P \forall x$$

Granularity

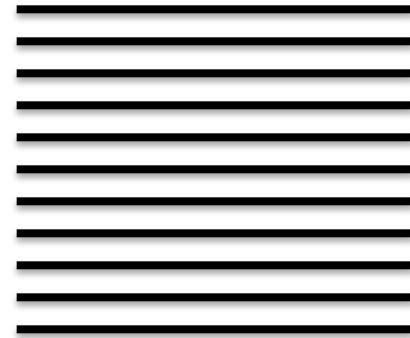

Hardware/Software

Computational Resource(s)

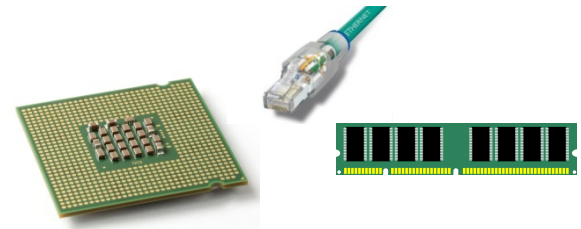

	Nondeterministic	Deterministic
Fine Grained	<ul style="list-style-type: none"> <li>DRAM Refresh Rate</li> <li>SRAM Soft Error Exposure</li> <li>Approximate Storage (PCM)</li> <li>Soft Fault Tolerance</li> <li>Synchronization Elision</li> <li>Voltage Overscaling</li> </ul>	<ul style="list-style-type: none"> <li>Bit-Width Reduction</li> <li>Float-to-Fixed Conversion</li> <li>Fuzzy Memoization</li> <li>Hierarchical FPU</li> <li>Load Value Approximation</li> <li>Lossy Compression and Data Packing</li> <li>Precision Scaling ALU</li> <li>Reduced-Precision FPU</li> <li>Underdesigned Multiplier</li> </ul>
Coarse Grained	<ul style="list-style-type: none"> <li>Error F.</li> <li>Neural Accel. (log)</li> </ul> 	<ul style="list-style-type: none"> <li>Algorithm Selection</li> <li>Code Perforation</li> <li>Interpolated Memoization</li> <li>Neural Acceleration (ASIC, FPGA, GPU)</li> <li>Parallel Pattern Replacement</li> <li>Parameter Adjustment</li> </ul>

# REACT

A Framework for **R**apid **E**xploration of **A**pproximate **C**omputing **T**echniques

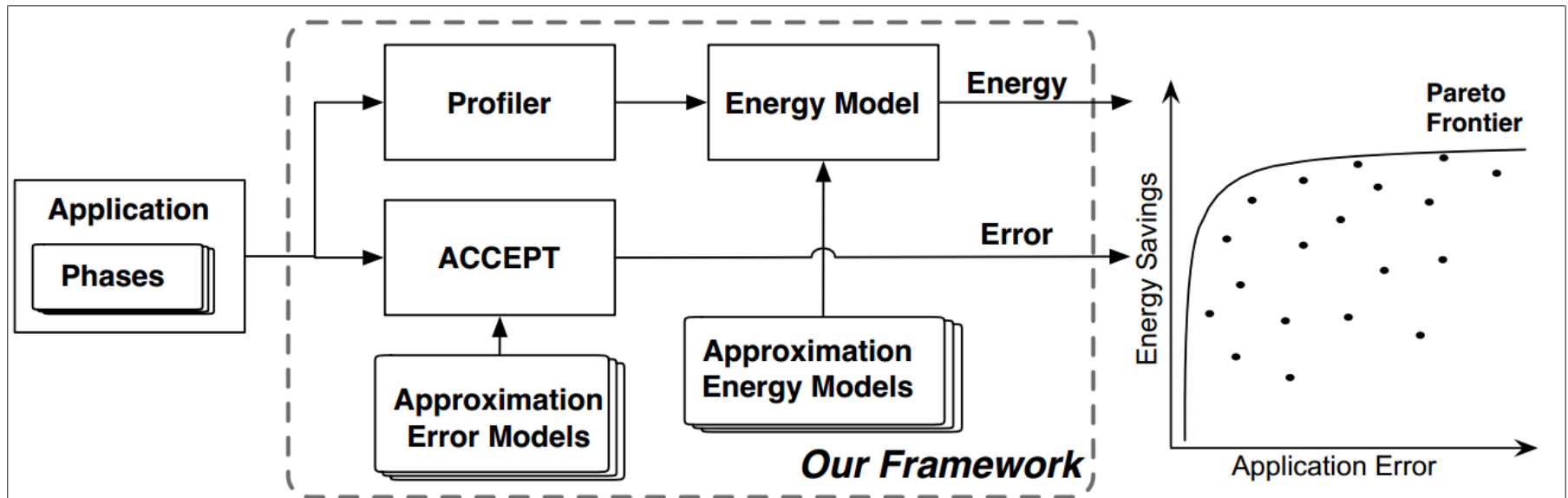

# Application Profiler & Energy Model

Intel Pin tool

Insn Count + Arch Events

Custom, linear model

Simple, understandable

Validated against McPAT

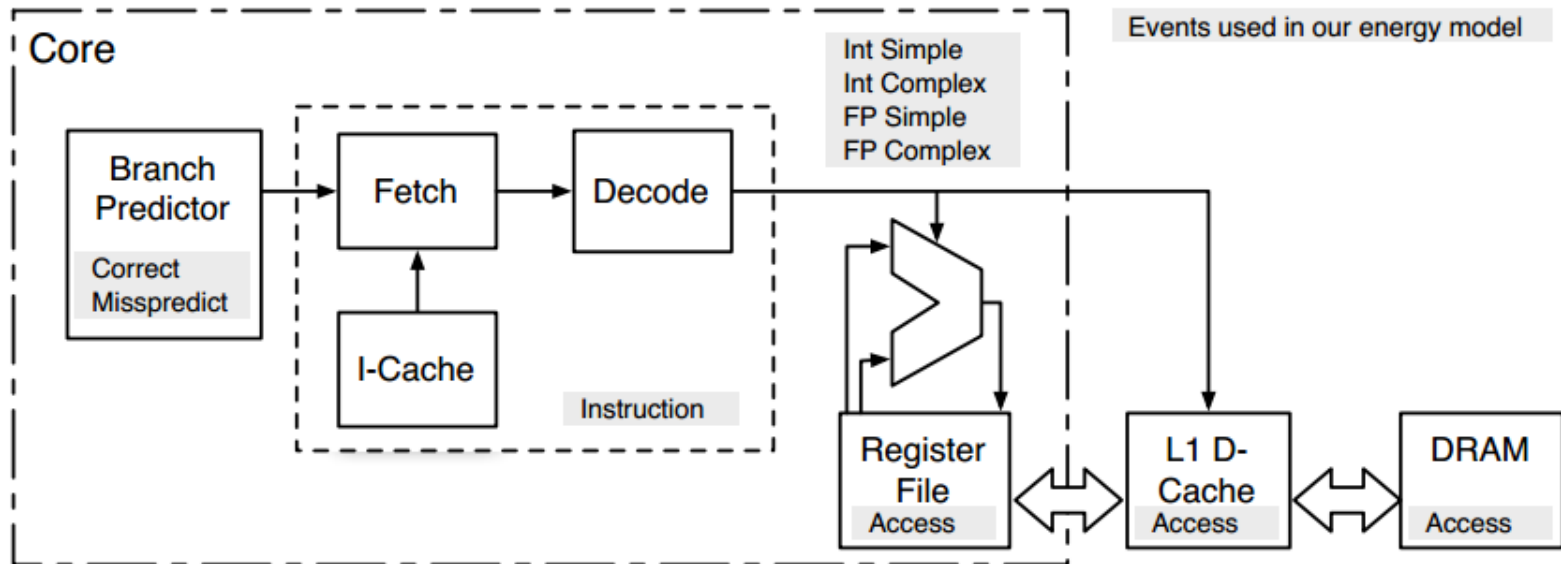

# Error Injection

ACCEPT

Runtime error injection

Simple API

Arbitrary error models

```
int i, p;  
APPROX int a;  
APPROX int data[N];  
a = data[i] * p;
```



# Approximation Models

Load Value Approximation

Neural Acceleration

*Drowsy SRAM*

Reduced Precision FPU

Low refresh rate DRAM

Voltage Overscaled ALU

# Early Results - Sobel

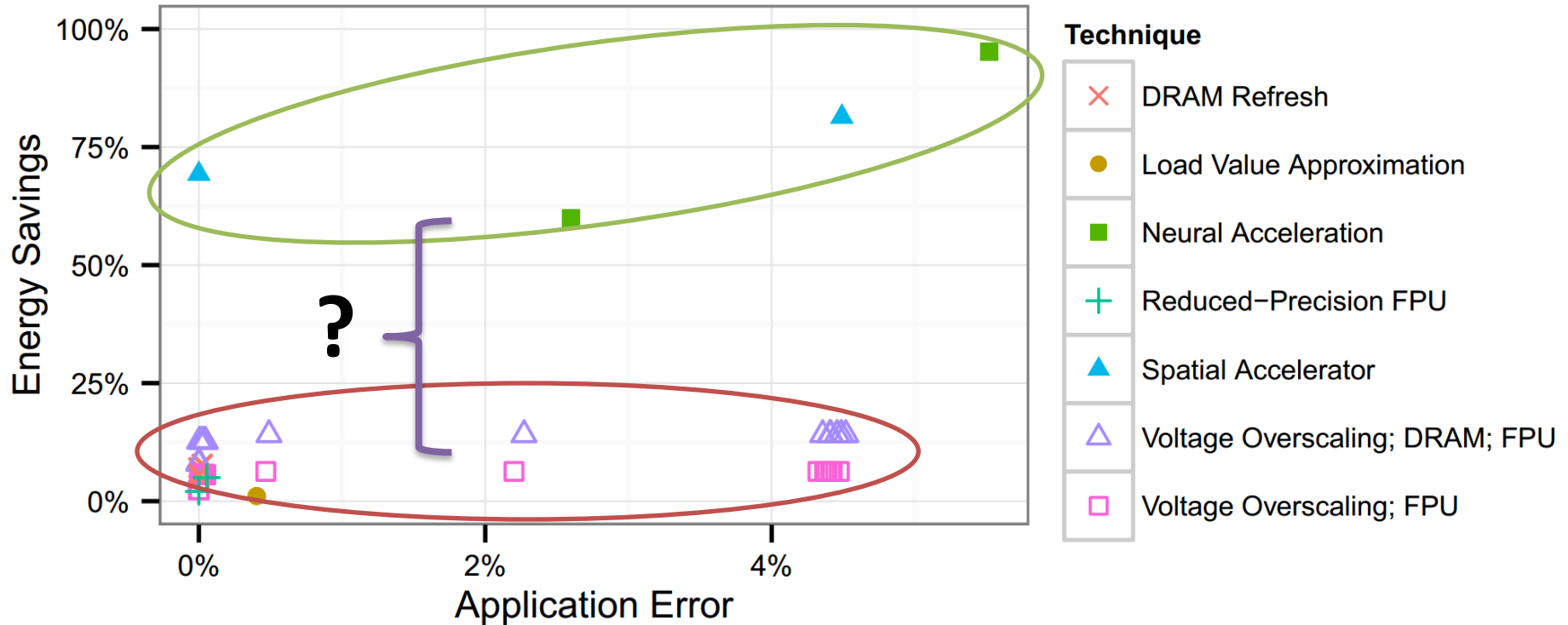

# Early Results – FFT1D

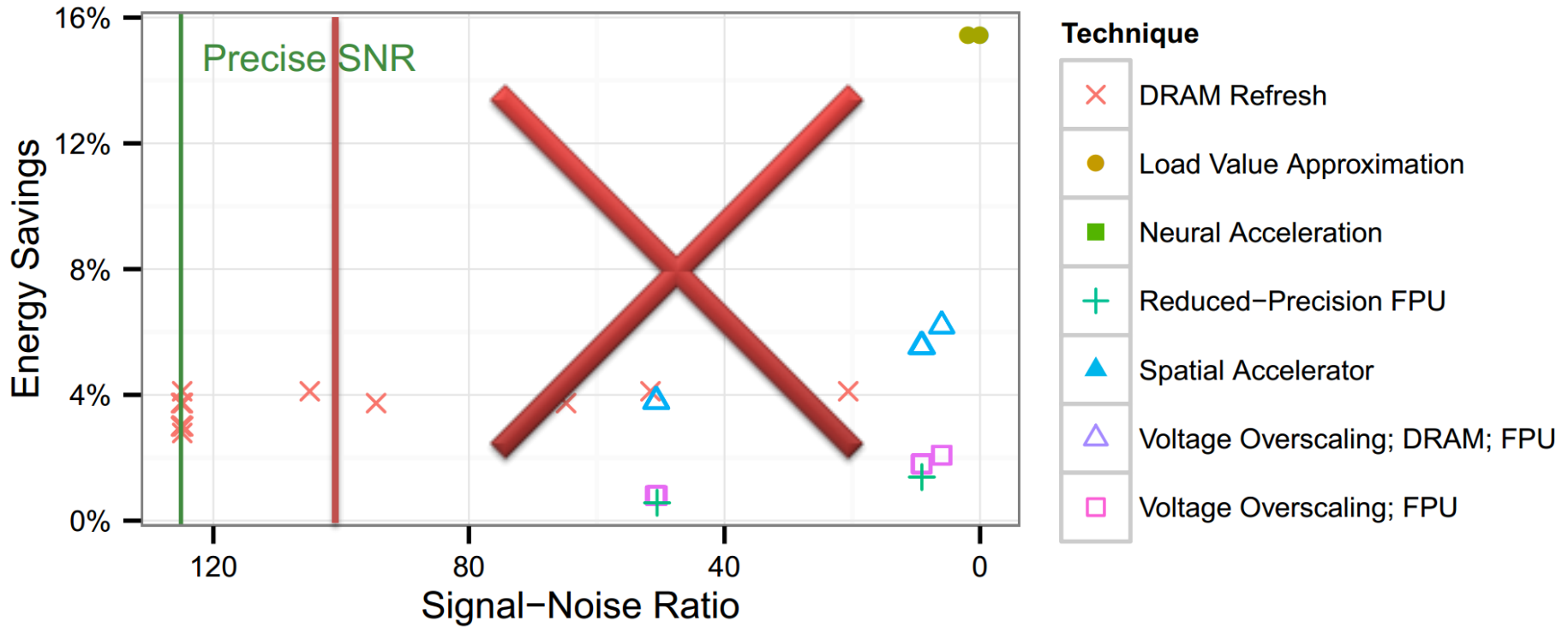

# Conclusions

Coarse-grained superior to fine-grained

Coarse-grained, Nondeterministic!

# Thank you!

Questions?