

CSE 403

Software Engineering

Winter 2023

Data modelling

From Requirements to System Design

From Requirements to System Design

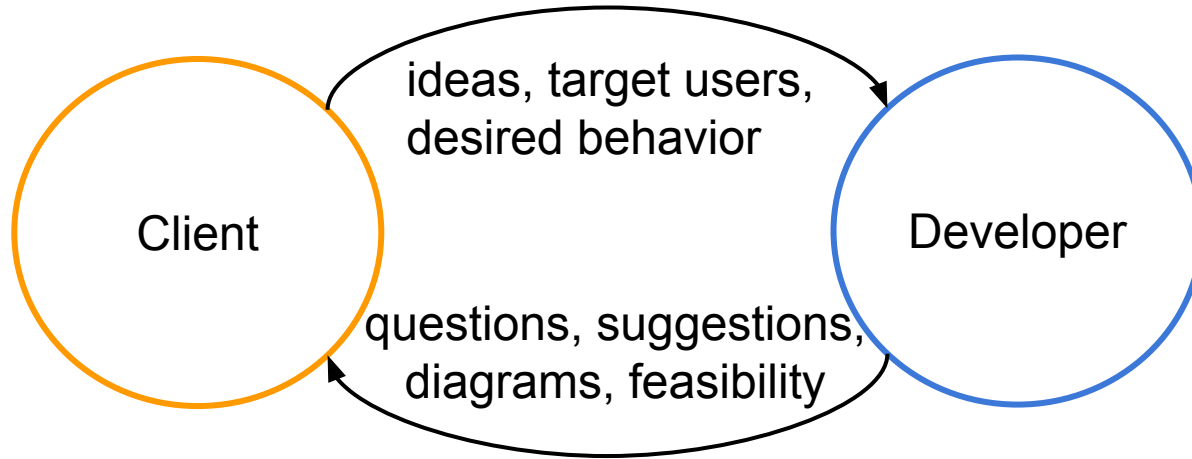

From Requirements to System Design

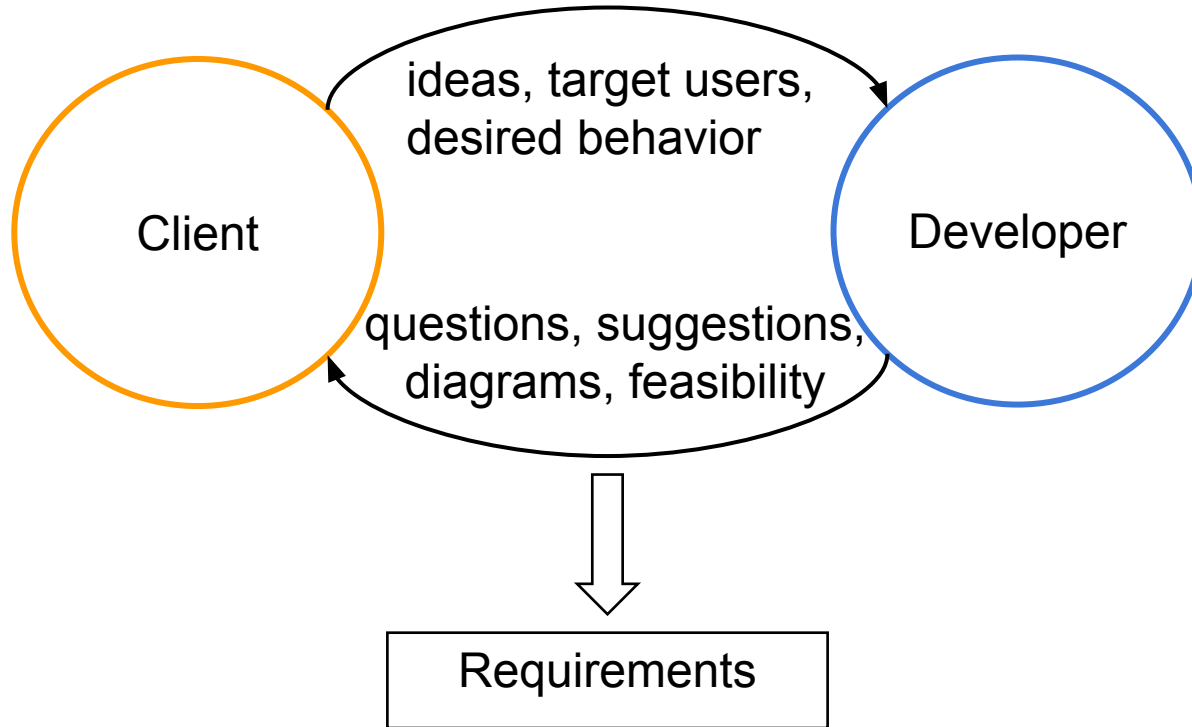

From Requirements to System Design

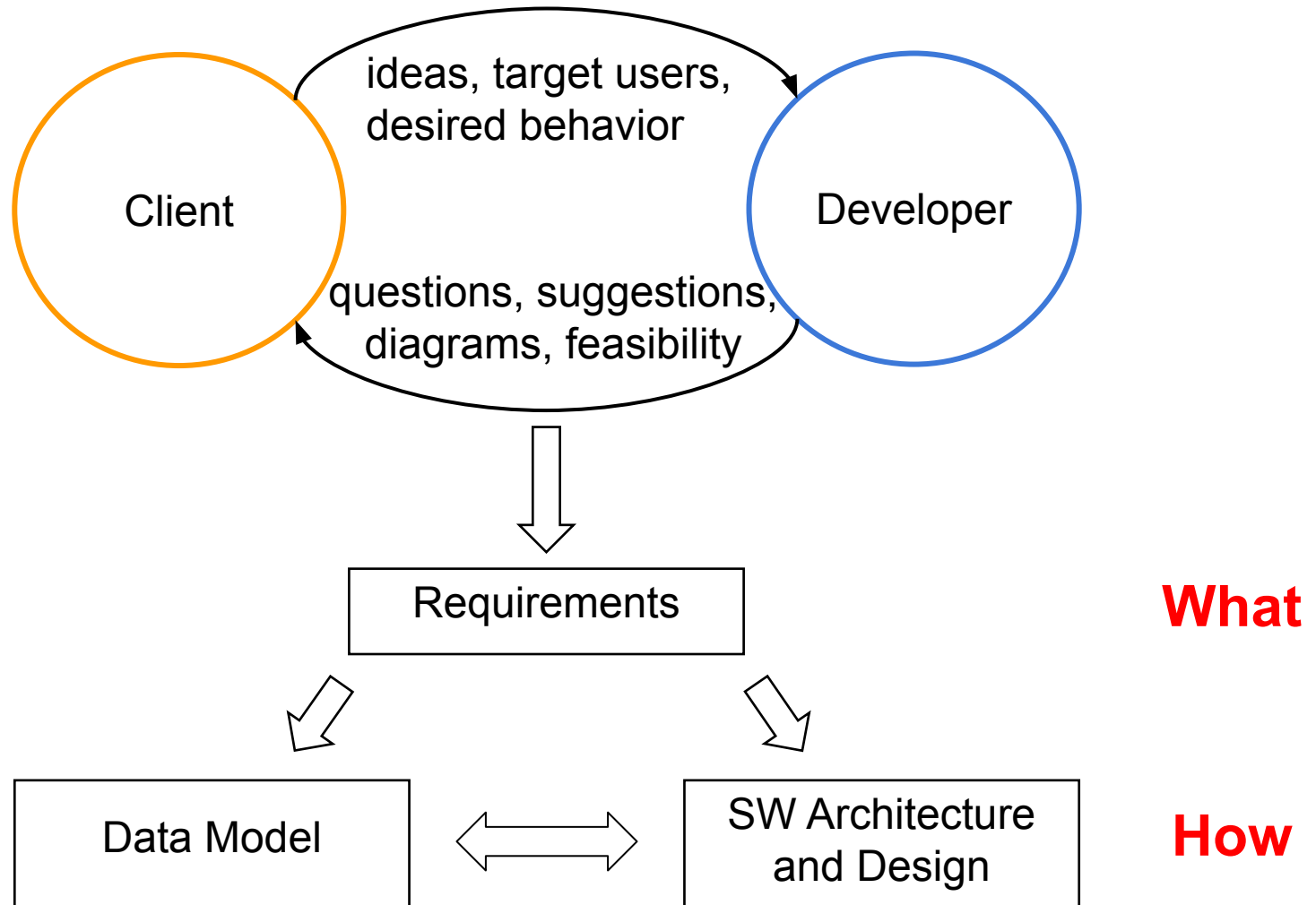

From Requirements to System Design

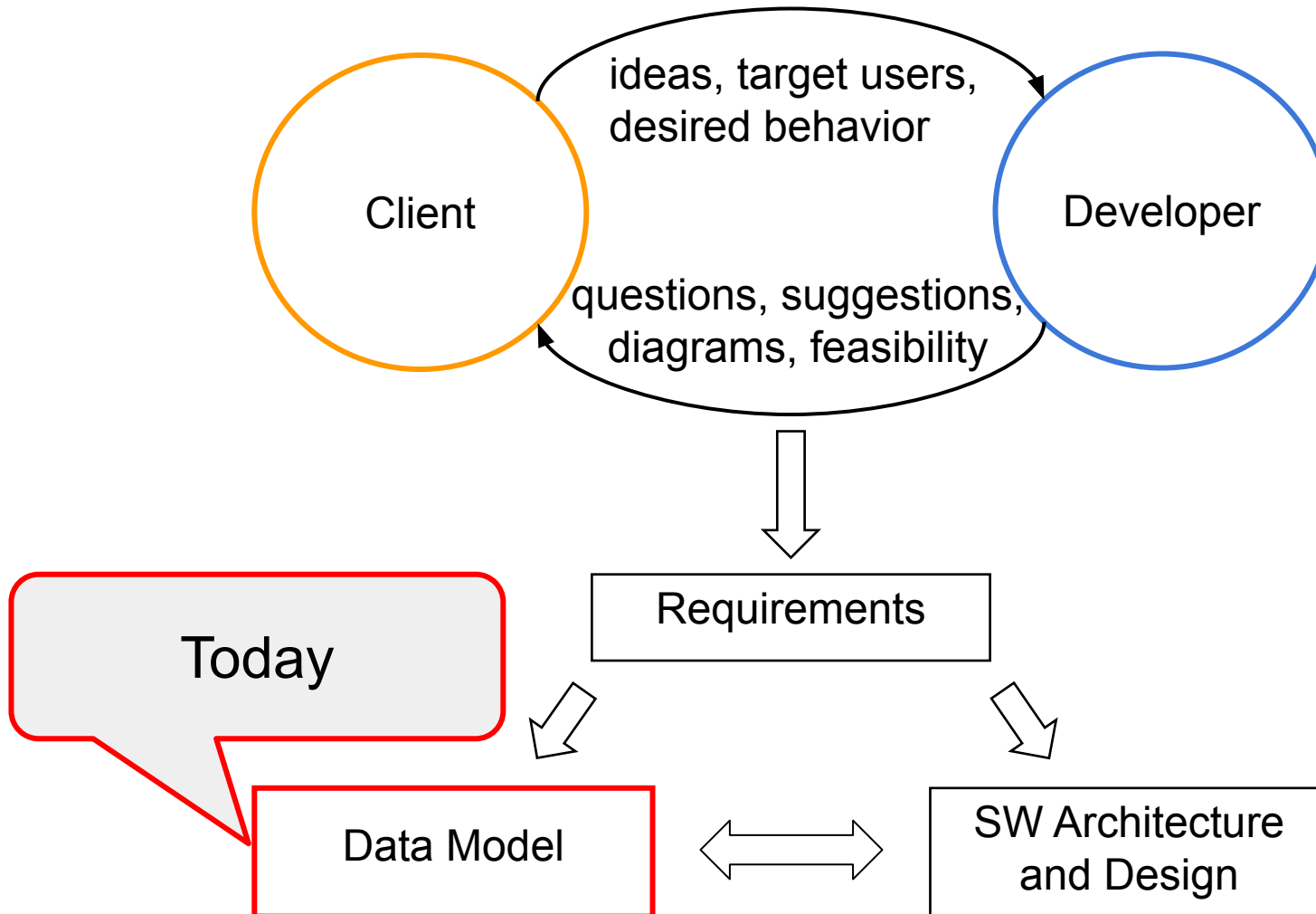

Data Modelling

Goals for today

- How to model data?
 - Identify Entities
 - Identify Attributes
 - Identify Relationships
 - Assign Keys
 - *(Normalization to reduce redundancy)*
 - *(Denormalization to improve performance)*
- Common “language” for data modelling
 - ER (Entity-Relationship) diagrams
 - Just one out of many possibilities (diagrams, tables, text)
- Develop a data model for a course-registration system

ER diagrams: overview

- An Entity Relationship (ER) diagram is a **graphical representation** of a **data model**.
- It shows the **relationship** between **entities** (e.g., people, objects, events, or concepts) within a system.
- It **can be mapped** to a **relational** (database) **schema**.

ER diagrams: graphical syntax

- An entity E



ER diagrams: graphical syntax

- An entity E

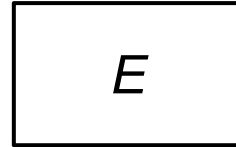

- An **attribute** A of entity E

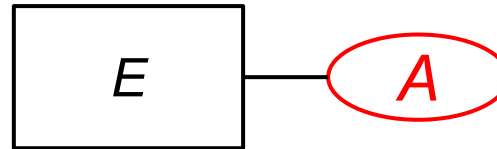

ER diagrams: graphical syntax

- An entity E

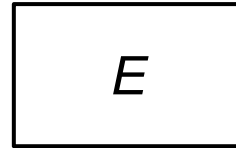

- An attribute A of entity E

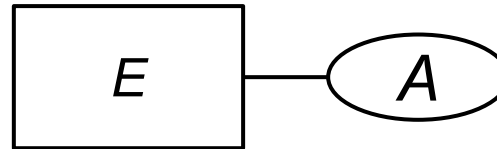

- A relationship R between two entities E_1 and E_2

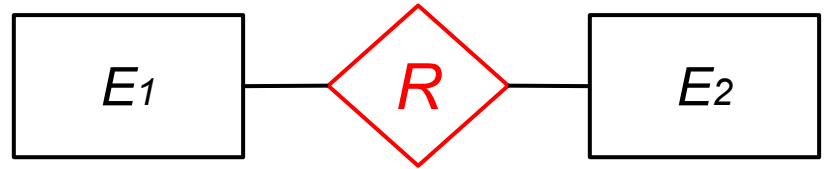

ER diagrams: graphical syntax

- An entity E

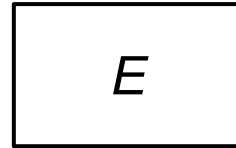

- An attribute A of entity E

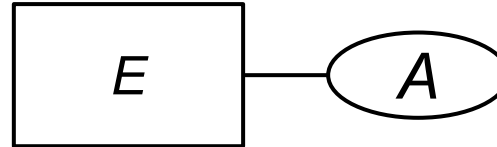

- A relationship R between two entities E_1 and E_2

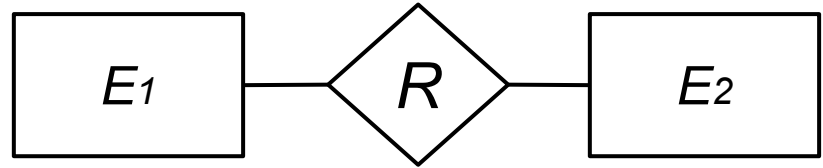

- An attribute B of relationship R

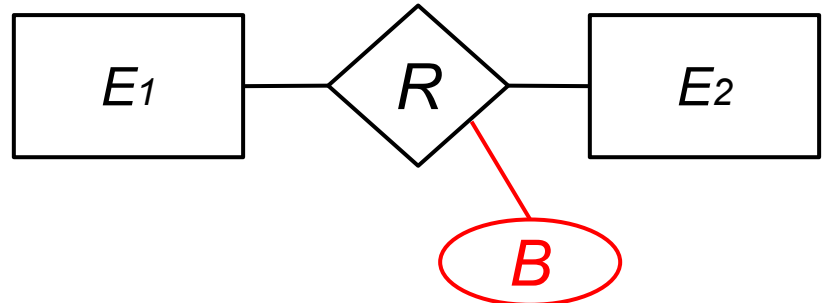

ER diagrams: rules

- An interconnecting line is only allowed between:
 - a box and a diamond,
 - a box and an oval,
 - a diamond and a oval.
- An oval must have exactly one connecting line.
- Names of boxes must be unique in the diagram.
- Names of ovals must be unique per box/diamond.

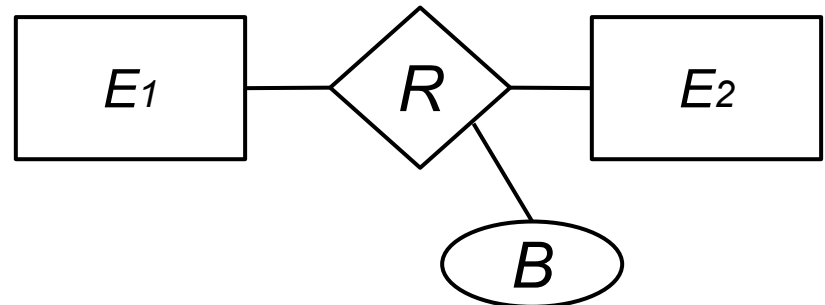
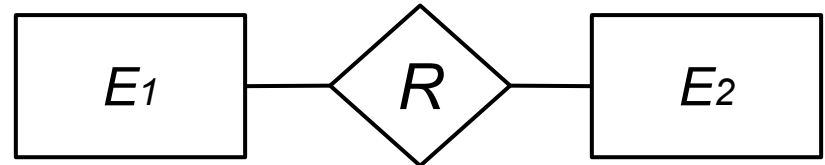
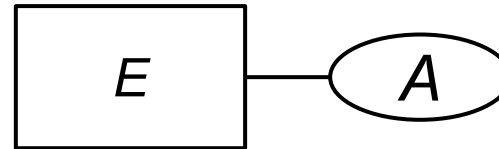
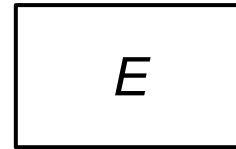

A first example

Let's model a simple course registration system:

- **Students**
- **Instructors**
- **Courses**

A first example: identify entities

Student

Instructor

Course

What attributes should we add?

A first example: identify attributes

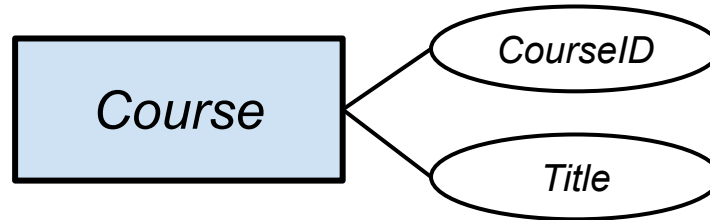
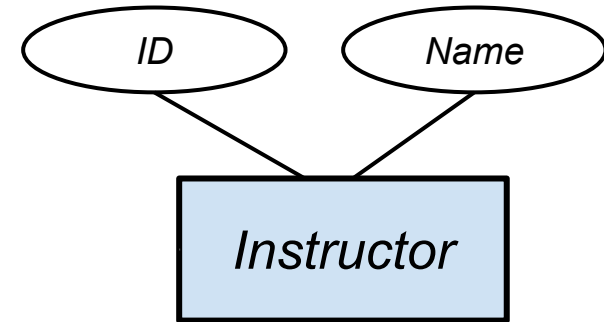
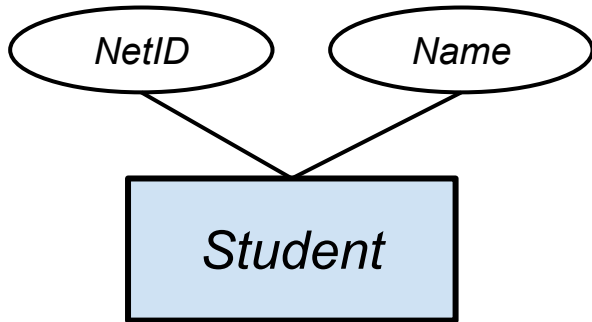

What relationships should we add?

A first example: identify relationships

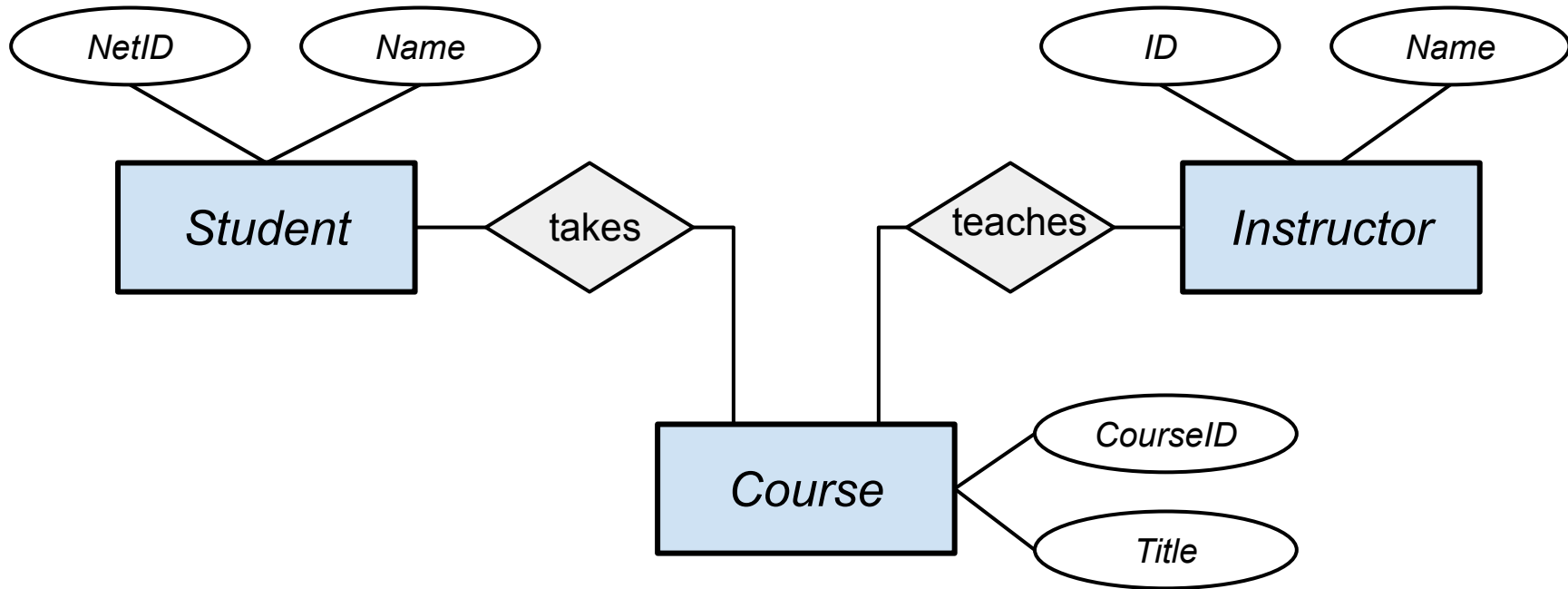

ER diagrams: keys and cardinalities

- A **key** is an (underlined) attribute, or a set of attributes, which **uniquely identifies an entity**.

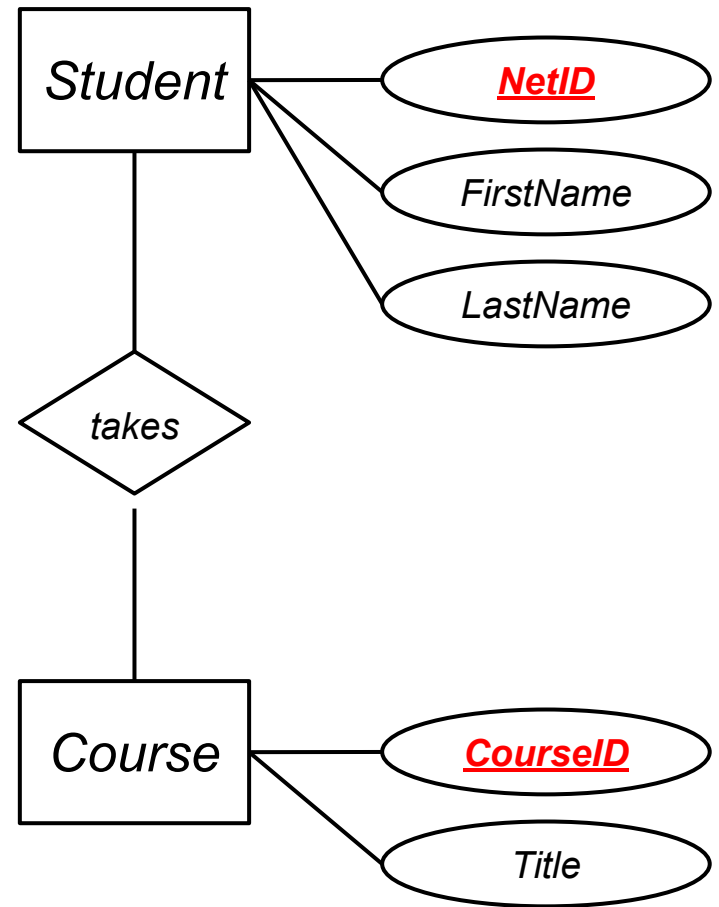

ER diagrams: keys and cardinalities

- A key is an (underlined) attribute, or a set of attributes, which uniquely identifies an entity.
- A key can be **artificial** or **natural**.

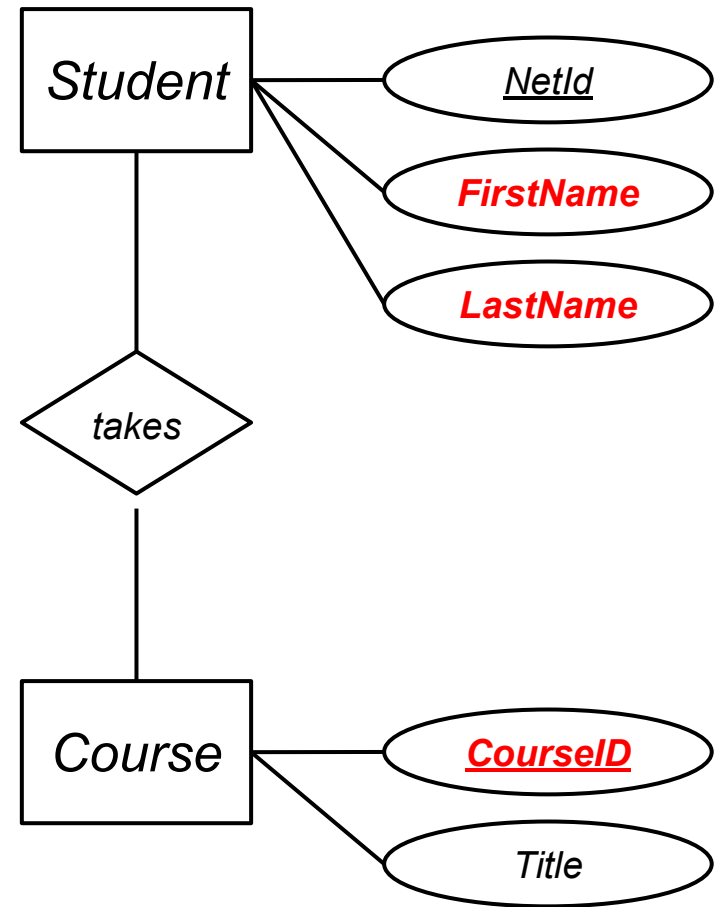

ER diagrams: keys and cardinalities

- A key is an (underlined) attribute, or a set of attributes, which uniquely identifies an entity.
- A key can be artificial or natural.
- The **cardinalities** define the kind of relationship (**one-to-one**, **one-to-many**, or **many-to-many**).
- There are different notations for cardinalities. For example:
 - 1 = (1,1)
 - c = (0,1)
 - m = (1,*)
 - mc = (0,*)

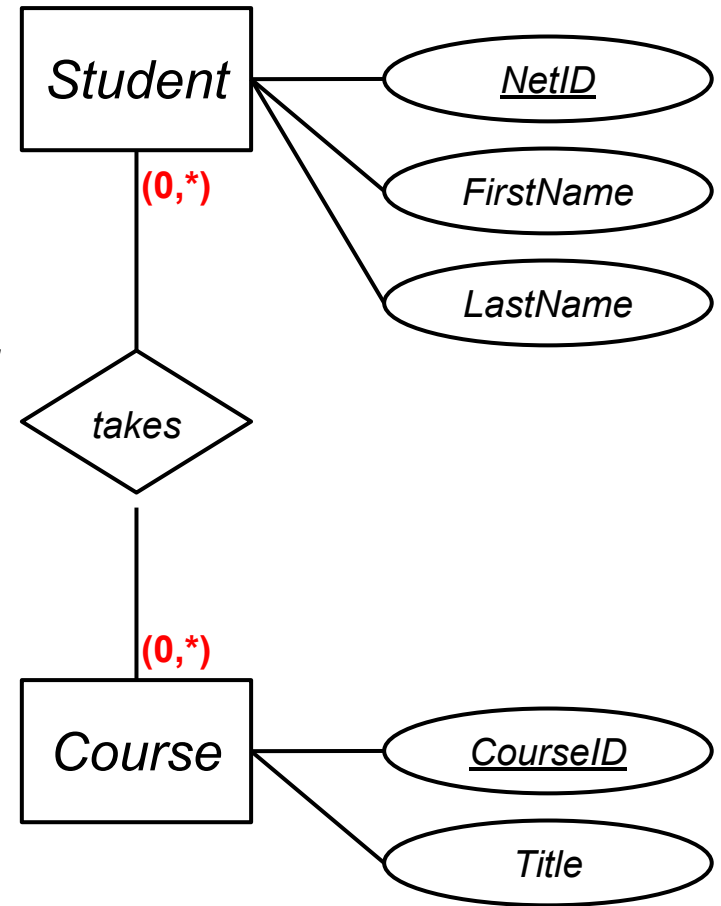

ER diagrams: weak entities

- A **weak entity** can't exist on its own (if a building is torn down, its rooms disappear).

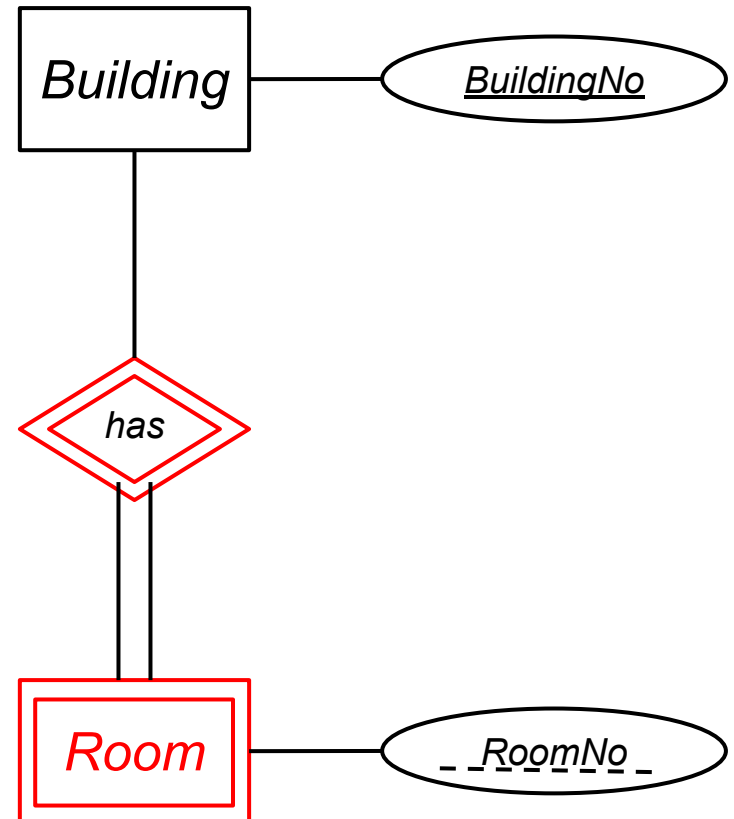

ER diagrams: weak entities

- A weak entity can't exist on its own (if a building is torn down, its rooms disappear).
- A weak entity is only **uniquely identifiable** in **reference** to **another entity**.

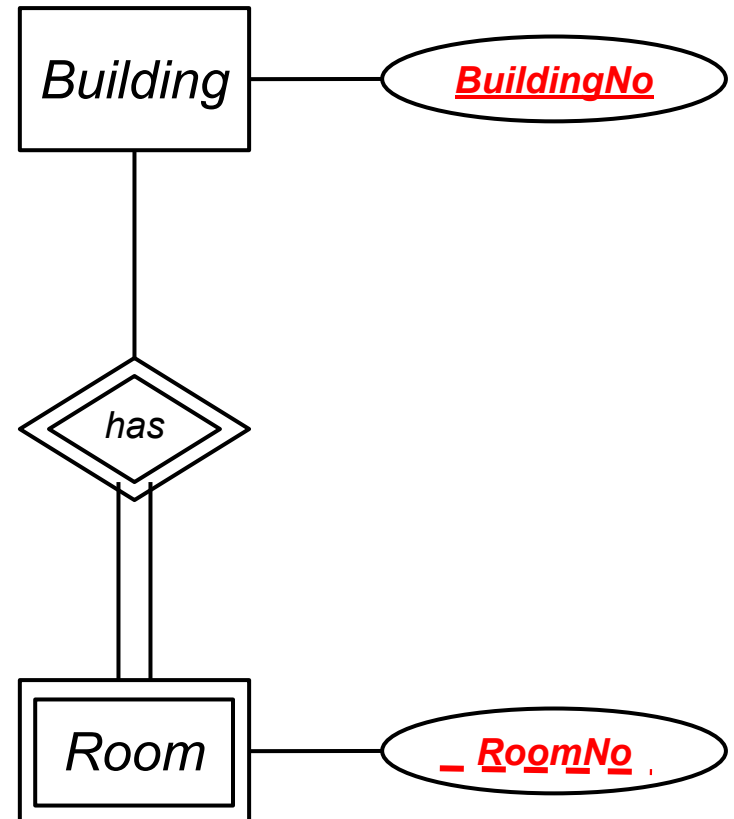

ER diagrams: self references and roles

- A **self reference** is usually explicitly annotated with **roles** to clarify the meaning of the self-referencing relationship.



Think about (but never draw) the following:

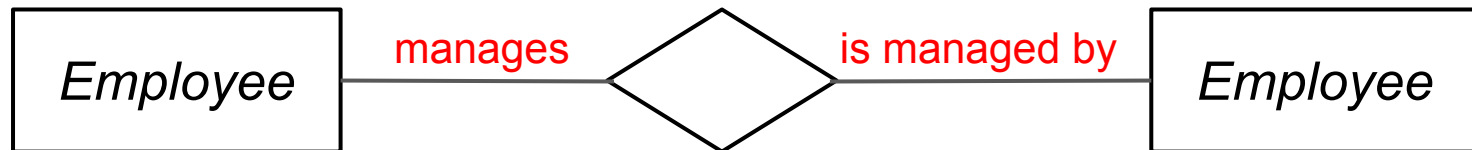

Putting it all together



Let's **augment** our **model** of a course registration system:

- Prerequisites
- Assignments
- Points/grades

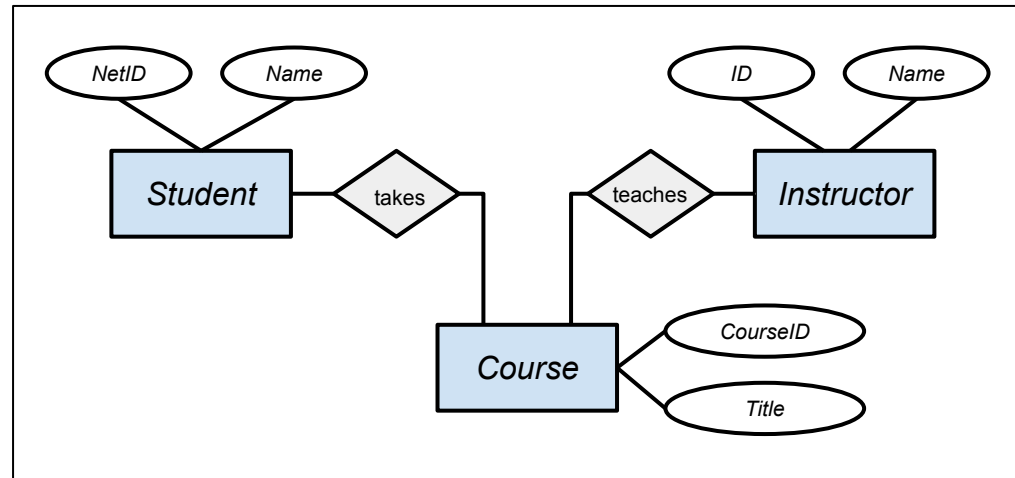

Instructions

<https://docs.google.com/presentation/d/1iUWnrOAwhrzkwPfp5AGXFdKUAfYSq-0oA-L9cbDyeCs/edit>

Putting it all together

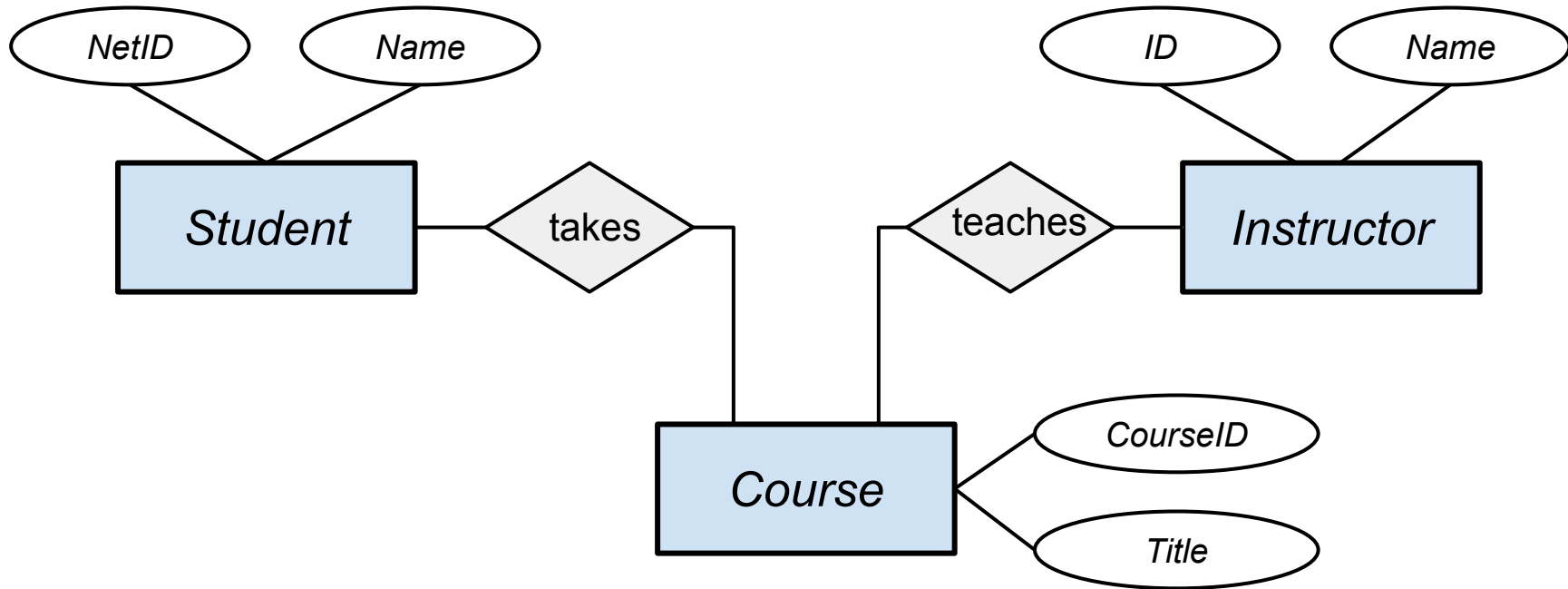

Putting it all together

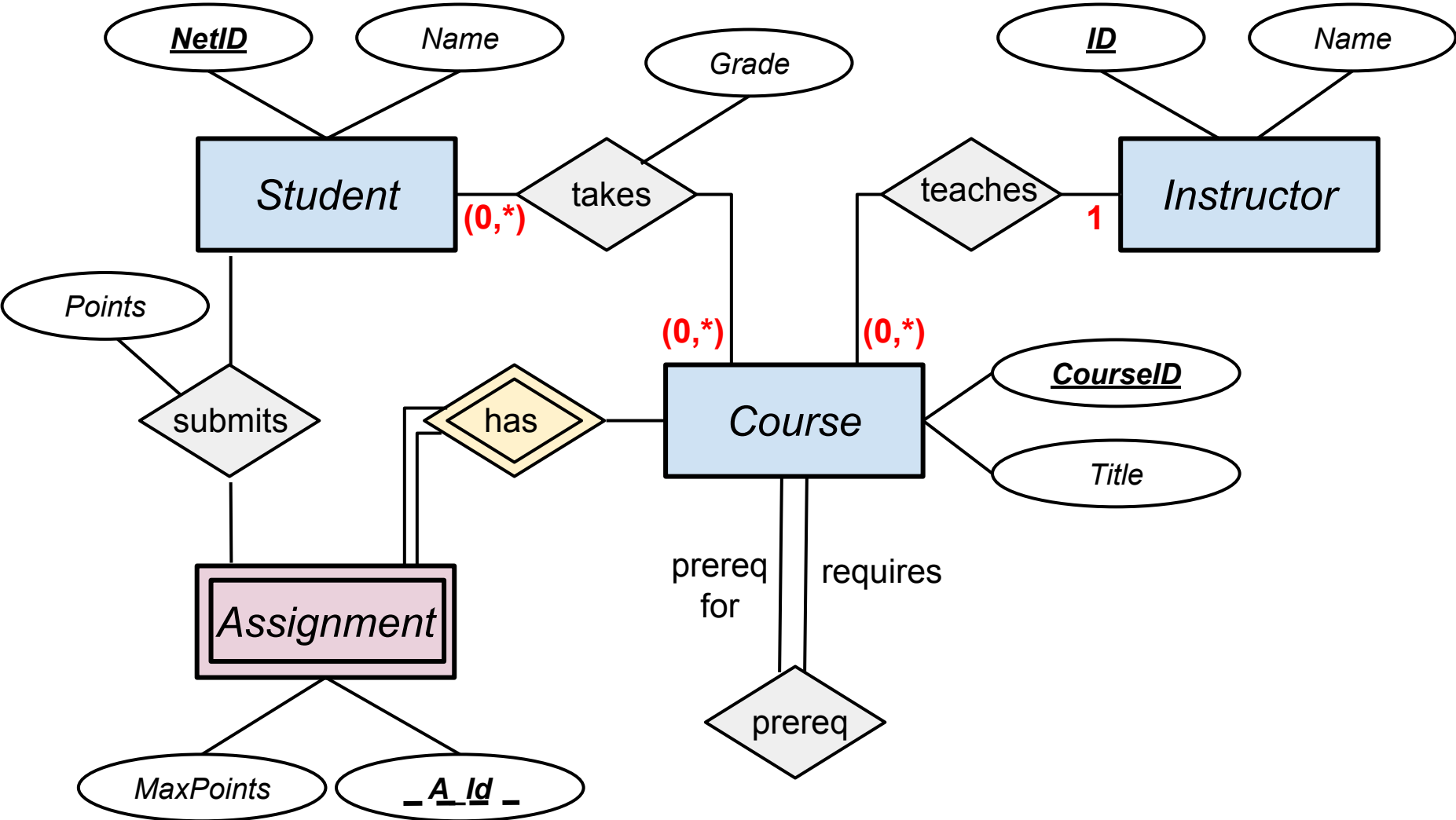

Additional material, not discussed in class

ER diagrams: generalization

- An **is_a** relationship represents a generalization relationship between two entities.

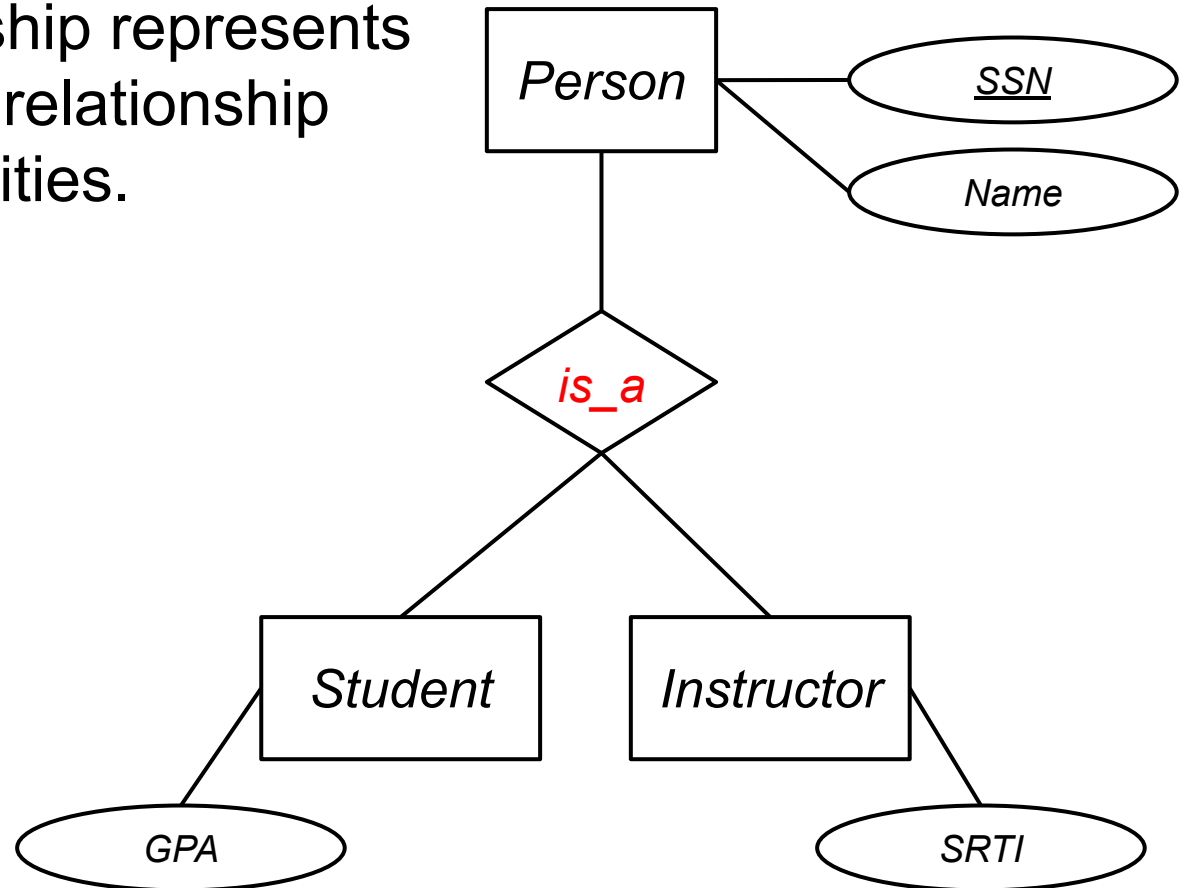

ER diagrams: generalization

- An `is_a` relationship represents a generalization relationship between two entities.
- **Attributes** (including keys) are “**inherited**”.

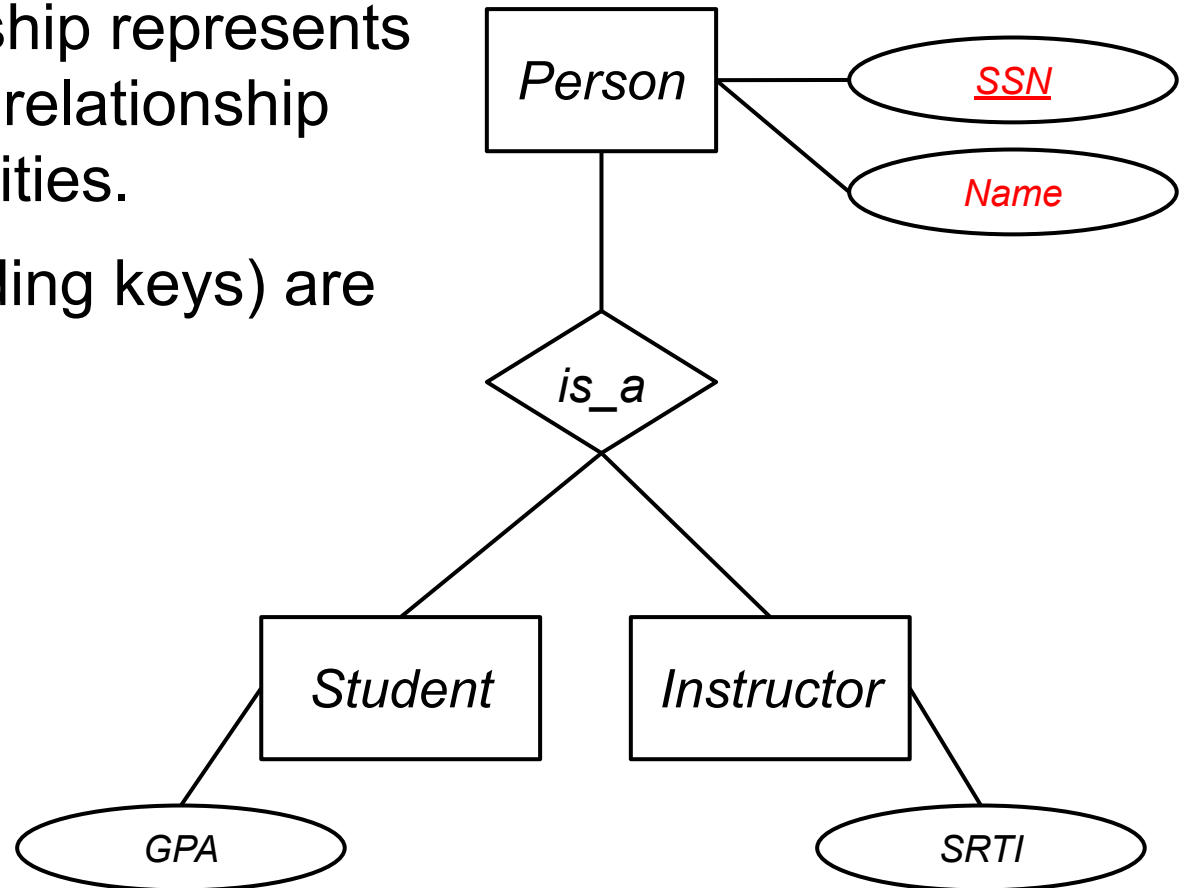

ER diagrams: generalization

- An *is_a* relationship represents a generalization relationship between two entities.
- Attributes (including keys) are “inherited”.
- **Additional attributes** can be defined.

